

# GOBO PRO - MODEL: ATL56F

W Track Luminaires

# WAC LIGHTING

PROJECT:

TYPE:

## Product Image



## Line Drawing

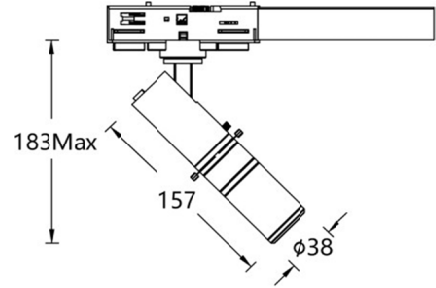

## Product Description

GOBO Pro-series LED projectors, adapted to the W three-circuit rail system, have a sophisticated design without a visible radiator, and a body made of aluminum alloy that can be cut through precise optical design. Like two functions. Cuts can be divided into four-leaf shade cuts and circular reducer cuts, which can be used to highlight artwork or wall accents in an exhibition environment, and can also be done by adding additional GOBOs. The piece projection shows text, logo, pattern, etc. It can be used in museums, exhibition halls, commercial spaces and other places..

## Product Features

- Body Material: Aluminum alloy die-casting
- Optical System: Multiple sets of optical lenses
- Finish: Static electricity powder coating
- Adjustable Angle: Aclinic 0~355°; Vertical 0-90°
- Accessories: As attached
- Certification: CCC
- IP Rating: IP20
- Insulation Level: Class I
- Operating Temperature: -20°C~40°C

## Product Specifications

- LED Type: COB
- LED Power: 10W
- Source Lm: 1000LM(3000K); 1100LM(4000K);
- LED Lifetime: >50000h-L70 /B10-Ta25°C(LM-80/TM-21)
- CCT/CRI: 3000K/4000K, Ra90
- SDCM: 3 SDCM
- Input: 220V~240V AC / 50Hz
- Dimming: On-boarding (dimming range 10%~100%)/  
Wireless dimming /0-10V
- Net Weight: 0.45Kg without packing

## Order Model

Model	LED	Dimming	Beam	CRI	CCT	Finish
ATL56F GOBO Pro	LM10 COB 10W	O On-boarding	R Reinvent	9 90	30 3000K	WT White
		D 0-10V Dimming		A 97	40 4000K	BK Black
		B Wireless				

Example: ATL56FLM10-OR930WT

Note: In the Beam bar code, R stands for four-leaf occlusion and circular shredding, and there are two functions

WAC Lighting  
www.waclighting.com (US)  
www.waclighting.net (International)

Headquarters  
44 Harbor Park Drive • Port Washington, NY  
Phone (516) 515.5000 • Fax (516) 515.5050

WAC Lighting(Shanghai)  
14,Lane 299, Bi Sheng Road, Shanghai 201204,China  
Phone (86.21) 3393.3558 • Fax (86.21) 3362.1598

WAC Lighting reserves the right to periodically design and update products. 2024-01-24

# GOBO PRO - MODEL: ATL56F

W Track Luminaires

# WAC LIGHTING

PROJECT:

TYPE:

GOBO Sheet Accessories	<b>LENS-ATL56F-GOBO</b> Accessories with WAC text GOBO tablets
------------------------	---

Note: All accessories need to be ordered separately; The luminaire leave the factory without GOBO sheets.

GOBO sheet size: Thickness 1mm,D: Ø 26mm, d: Ø 13mm .The text or graphic content can be customized (the diameter cannot exceed d).

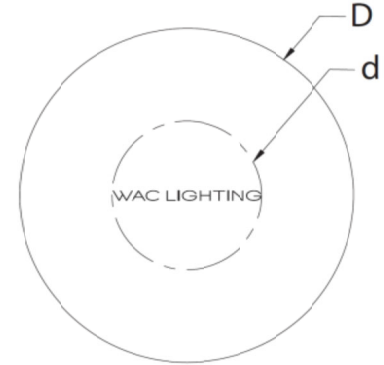

## LIGHT DISTRIBUTION@3000K LUMINAIRE DATA

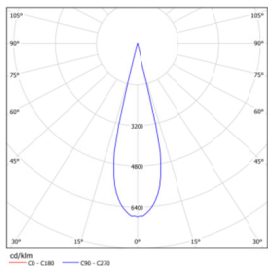

<b>MODEL:</b>	ATL56FLM10 Narrow angle
<b>BEAM ANGLE:</b>	18°
<b>POWER:</b>	10.5W
<b>LUMENS:</b>	222lm
<b>CBCP:</b>	3006cd
<b>EFFICACY:</b>	21lm/W

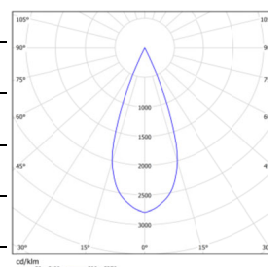

<b>MODEL:</b>	ATL56FLM10 Wide angle
<b>BEAM ANGLE:</b>	36°
<b>POWER:</b>	10.5W
<b>LUMENS:</b>	183lm
<b>CBCP:</b>	645cd
<b>EFFICACY:</b>	17.5lm/W

# GOBO PRO - MODEL: ATL57F

W Track Luminaires

# WAC LIGHTING

PROJECT:

TYPE:

## Product Image



## Line Drawing

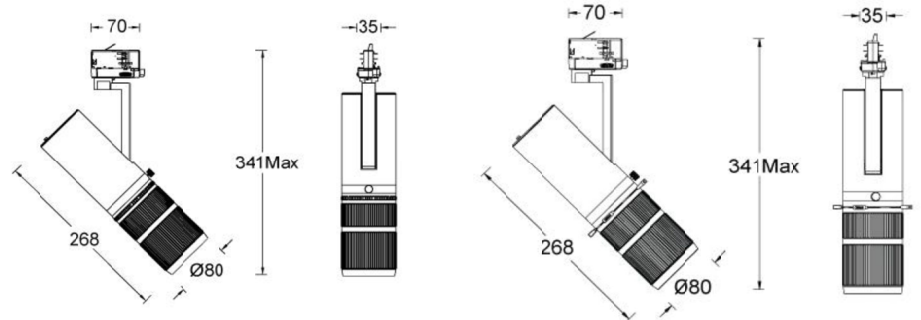

TL57FLM25-\*-F

TL57FLM25-\*-R

## Product Description

GOBO Pro-series LED projectors, adapted to the W three-circuit rail system, have a sophisticated design without a visible radiator, and a body made of aluminum alloy that can be cut through precise optical design. Like two functions. Cuts can be divided into four-leaf shade cuts and circular reducer cuts, which can be used to highlight artwork or wall accents in an exhibition environment, and can also be done by adding additional GOBOs. The piece projection shows text, logo, pattern, etc. It can be used in museums, exhibition halls, commercial spaces and other places.

## Product Features

- Body Material: Aluminum alloy die-casting
- Optical System: Multiple sets of optical lenses
- Finish: Static electricity powder coating
- Adjustable Angle: Aclinic 0~355°; Vertical 0-90°
- Accessories: As attached
- Certification: CCC
- IP Rating: IP20
- Insulation Level: Class I
- Operating Temperature: -20°C~40°C

## Product Specifications

- LED Type: COB
- LED Power: 25W
- Source Lm: 2600LM(3000K); 2800LM(4000K);
- LED Lifetime: >50000h-L70 /B10-Ta25°C(LM-80/TM-21)
- CCT/CRI: 3000K/4000K,2700K-6000K (Tunable)  
>Ra90
- SDCM: 3 SDCM
- Input: 220V~240V AC / 50Hz
- Dimming: On-boarding (dimming range 10%~100%)/  
DALI /0-10V
- Net Weight: 1.6Kg without packing

## Order Model

Model	LED	Dimming	Beam	CRI	CCT	Finish
TL57F GOBO Pro	LM25 COB 25W	O On-boarding	R Reinvent F Focus	9 90 A 97	30 3000K	WT White BK Black
		D 0-10V Dimming			40 4000K	
		A DALI			CC 2700K-6000K (Tunable)	
		A DALI				

Example: TL57FLM25-O-R930WT

Note: In the Beam bar code, R stands for four-leaf occlusion and light cutting, and this optical accessory comes with the factory by default;  
F stands for Circular Variable Diameter Cut, which comes with this optical accessory by default.

WAC Lighting  
www.waclighting.com (US)  
www.waclighting.net (International)

Headquarters  
44 Harbor Park Drive • Port Washington, NY  
Phone (516) 515.5000 • Fax (516) 515.5050

WAC Lighting(Shanghai)  
14,Lane 299, Bi Sheng Road, Shanghai 201204,China  
Phone (86.21) 3393.3558 • Fax (86.21) 3362.1598

WAC Lighting reserves the right to periodically design and update products. 2024-01-24



# GOBO PRO - MODEL: ATL57F

W Track Luminaires

# WAC LIGHTING

PROJECT:

TYPE:

Cutting accessories	<b>LENS-ATL57F-F</b> The cutting mode is blocked by R four blades Change to F circular reducing cutting mode		<b>LENS-ATL57F-R</b> Cut light by F circular reduction Change to R four-blade occlusion cutting mode	
GOBO Sheet Accessories	<b>LENS-ATL56F-GOBO</b> Accessories with WAC text GOBO tablets			

Note: All accessories need to be ordered separately, see the instructions for installation; The luminaire comes with a corresponding trimming accessory and does not include the GOBO sheet. The trimming accessories are interchangeable and can be retrofitted at the same time as the GOBO sheet, but only one trimming accessory can be added to each fixture.

GOBO sheet size: Thickness 1mm,D: Ø 33mm,d: Ø 14mm.The text or graphic content can be customized (the diameter cannot exceed d).

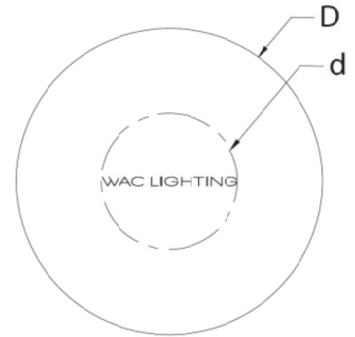

## LIGHT DISTRIBUTION@3000K LUMINAIRE DATA

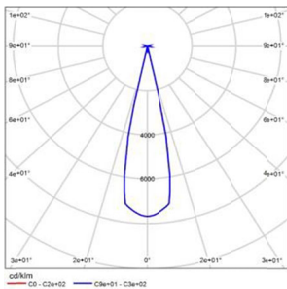

<b>MODEL:</b>	ATL57FLM25 Narrow angle
<b>BEAM ANGLE:</b>	24°
<b>POWER:</b>	28W
<b>LUMENS:</b>	692lm
<b>CBCP:</b>	5315cd
<b>EFFICACY:</b>	25lm/W

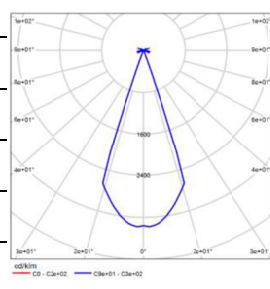

<b>MODEL:</b>	ATL57FLM25 Wide angle
<b>BEAM ANGLE:</b>	40°
<b>POWER:</b>	28W
<b>LUMENS:</b>	763lm
<b>CBCP:</b>	2562cd
<b>EFFICACY:</b>	27lm/W