

W Track Luminaires

PROJECT :

TYPE :

Product Image



Line Drawing

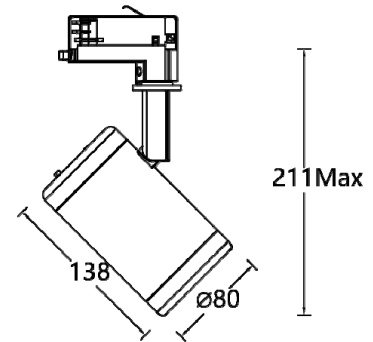

Product Description

The MERE series LED track spotlights have a modular design and are suitable for W track systems. The design of the lamp is exquisite, there is no visible radiator, and the lamp body is made of die-cast aluminum. With multi-particle HP LED light module, it can provide a rich beam Angle configuration, and more importantly, different beam Angle accessories can be changed by hand in the field, which can be used for key lighting or environmental lighting. The built-in light fixture has no strobe drive, and the dimming module can also be replaced in different ways on the spot, which is widely used in museums, art galleries, commercial Spaces, hotels, retail stores and other places.

Product Features

- Body Material: Aluminum alloy die-cast lamp body
- Optical System: Lens + reflector
- Finish: Electrostatic Powder coating, Black (BK), White (WT)
- Adjustable Angle: Horizontal 0 ~365 °, Vertical 0 ~90 °
- Accessories/Brackets: Refer to the accessories list, each type of accessories can only be added one
- Certification: CCC/CE
- IP Rating: IP20
- Insulation Level: Class I
- Operating Temperature: -20°C~40°C
- Net Weight: 0.9Kg without packing

Product Specifications

- LED Type: HP LED
- LED Power: 8W(4*2W)/12W(4*3W), built-in power shift
- Source Lm: 2700K: 770lm(8W)/1150lm(12W)
3000K: 800lm(8W)/1200lm(12W)
3500K: 820lm(8W)/1240lm(12W)
4000K: 860lm(8W)/1300lm(12W)
- LED Lifetime: >50000h-L70 /B10-Ta25°C (LM-80/TM-21)
- CCT/CRI: 2700K/3000K/3500K/4000K, Ra90 or Ra97(> 95)
- SDCM: 2SDCM
- Input: 220V~240V AC/50Hz
- Dimming: On-board &0-10V, DALI(A match test is required)

Order Model

Model	LED	Dimming	Beam	CRI	CCT	Finish
ATL36S MERE	LD08 LED 8W LD12 LED 12W	D 0-10V&On-board A DALI	S 6°	9 90 A 97	27 2700K 30 3000K 35 3500K 40 4000K	WT White BK Black
			N 10°			
			1 15°			
			2 24°			
			3 36°			
			5 50°			
			E 10*50°			
			G 25*55°			
W Wash						
ATL36S	LD12	D	2	9	30	WT

























Example : ATL36SLD12-D2930WT

W Track Luminaires

PROJECT :

TYPE :

Accessories

First class fittings	Lens "Angle S"  LENS-ATL36-HSBK	Lens "Angle N"  LENS-ATL36-HNBK	Lens "Angle 1"  LENS-ATL36-H1BK	Lens "Angle 2"  LENS-ATL36-H2BK	Lens "Angle 3"  LENS-ATL36-H3BK
	Lens "Angle 5"  LENS-ATL36-H5BK	Lens "Angle E"  LENS-ATL36-HEBK	Lens "Angle G"  LENS-ATL36-HGBK		
Second class fittings	Flat lens  "wall washing" LENS-ATL36-WWWT	Flat lens  "stretching" LENS-ATL36-EEWT	Flat lens  "Weak mixed light " LENS-ATL36-SSWT	Flat lens  "Medium mixed light " LENS-ATL36-MMWT	Flat lens  "Strong mixed light " LENS-ATL36-LLWT
Third class fittings	Filters "nostalgia"  LENS-ATL36-HSWT		Filters "identifiability"  LENS-ATL36-RGWT		Filters "preference"  LENS-ATL36-PFWT
Fourth class fittings	Rimmed honeycomb  LENS-ATL36-HCM	All black condenser  White outside and black inside condenser  LENS-ATL36-SNOOT-B LENS-ATL36-SNOOT-W			
Fifth class fittings	Black four-leaf shade  LENS-ATL36-BD-BK	White four-leaf shade  LENS-ATL36-BD-WT			
Sixth class fittings	On-board &0~10V Dimmer module (black)  PART-ATL36-D-BK	On-board &0~10V Dimming module (white)  PART-ATL36-D-WT	DALI Dimmer module (Black)  PART-ATL36-A-BK	DALI Dimmer Modul (White)  PART-ATL36-A-WT	

Note: Up to six types of accessories can be installed, and each type of accessories can be installed at most one at the same time

Track connection diagram

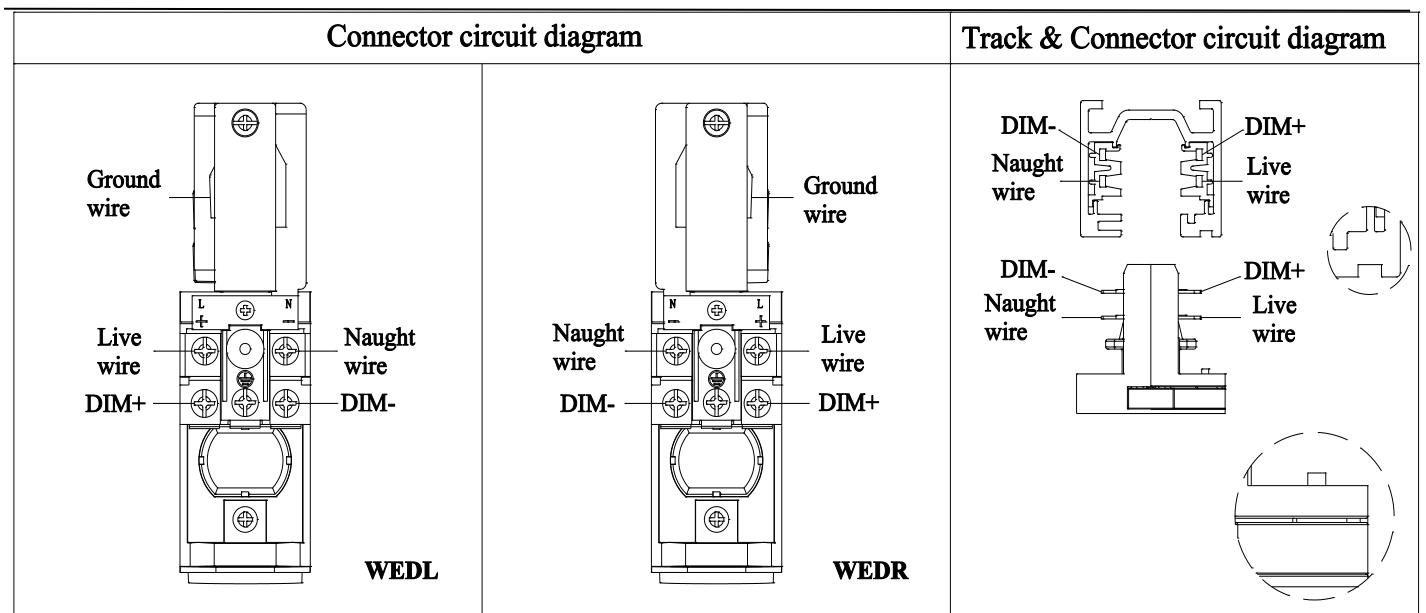

MERE- MODEL: ATL37SLD

WAC LIGHTING

W Track Luminaires

PROJECT :

TYPE :

Product Image



Line Drawing

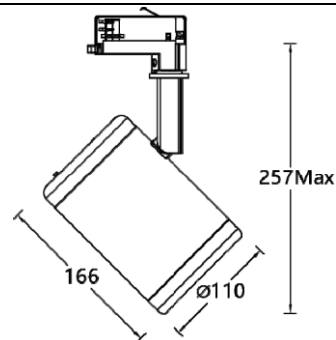

Product Description

The MERE series LED track spotlights have a modular design and are suitable for W track systems. The design of the lamp is exquisite, there is no visible radiator, and the lamp body is made of die-cast aluminum. With multi-particle HP LED light module, it can provide a rich beam Angle configuration, and more importantly, different beam Angle accessories can be changed by hand in the field, which can be used for key lighting or environmental lighting. The built-in light fixture has no strobe drive, and the dimming module can also be replaced in different ways on the spot, which is widely used in museums, art galleries, commercial Spaces, hotels, retail stores and other places.

Product Features

- Body Material: Aluminum alloy die-cast lamp body
- Optical System: Lens + reflector
- Finish: Electrostatic Powder coating, Black (BK), White (WT)
- Adjustable Angle: Horizontal 0 ~365 °, Vertical 0 ~90 °
- Accessories/Brackets: Refer to the accessories list, each type of accessories can only be added one
- Certification: CCC/CE
- IP Rating: IP20
- Insulation Level: Class I
- Operating Temperature: -20°C~40°C
- Net Weight: 0.1.8Kg without packing

Product Specifications

- LED Type: HP LED
- LED Power: 18W(9*2W)/27W(9*3W), built-in power shift
- Source Lm: 2700K: 1730lm(18W)/2580lm(27W)
3000K: 1800lm(18W)/2700lm(27W)
3500K: 1850lm(18W)/2780lm(27W)
4000K: 1950lm(18W)/2950lm(27W)
- LED Lifetime: >50000h-L70 /B10-Ta25°C (LM-80/TM-21)
- CCT/CRI: 2700K/3000K/3500K/4000K, Ra90 or Ra97(> 95)
- SDCM: 2SDCM
- Input: 220V~240V AC/50Hz
- Dimming: On-board &0-10V, DALI(A match test is required)

Order Model

Model	LED	Dimming	Beam	CRI	CCT	Finish
ATL37S MERE	LD18 LED 18W	D 0-10V&On-board A DALI	S 6°	9 90 A 97	27 2700K 30 3000K 35 3500K 40 4000K	WT White BK Black
			N 10°			
	1 15°					
	2 24°					
	3 36°					
	5 50°					
	E 10*50°					
	G 25*55°					
	W Wash					
	ATL37S		LD27			

























Example : ATL37SLD27-D2930WT

W Track Luminaires

PROJECT :

TYPE :

Accessories

First class fittings	Lens "Angle S"  LENS-ATL37-HSBK	Lens "Angle N"  LENS-ATL37-HNBK	Lens "Angle 1"  LENS-ATL37-H1BK	Lens "Angle 2"  LENS-ATL37-H2BK	Lens "Angle 3"  LENS-ATL37-H3BK
	Lens "Angle 5"  LENS-ATL37-H5BK	Lens "Angle E"  LENS-ATL37-HEBK	Lens "Angle G"  LENS-ATL37-HGBK		
Second class fittings	Flat lens "wall washing"  LENS-ATL37-WWWT	Flat lens "stretching"  LENS-ATL37-EEWT	Flat lens "Weak mixed light"  LENS-ATL37-SSWT	Flat lens "Medium mixed light"  LENS-ATL37-MMWT	Flat lens "Strong mixed light"  LENS-ATL37-LLWT
Third class fittings	Filters "nostalgia"  LENS-ATL37-HSWT		Filters "identifiability"  LENS-ATL37-RGWT		Filters "preference"  LENS-ATL37-PFWT
Fourth class fittings	Rimmed honeycomb  LENS-ATL37-HCM	All black condenser  LENS-ATL37-SNOOT-B			White outside and black inside condenser  LENS-ATL37-SNOOT-W
Fifth class fittings	Black four-leaf shade  LENS-ATL37-BD-BK	White four-leaf shade  LENS-ATL37-BD-WT			
Sixth class fittings	On-board &0~10V Dimmer module (black)  PART-ATL37-D-BK	On-board &0~10V Dimming module (white)  PART-ATL37-D-WT	DALI Dimmer module (Black)  PART-ATL37-A-BK	DALI Dimmer Module (White)  PART-ATL37-A-WT	

Note: Up to six types of accessories can be installed, and each type of accessories can be installed at most one at the same time

Track connection diagram

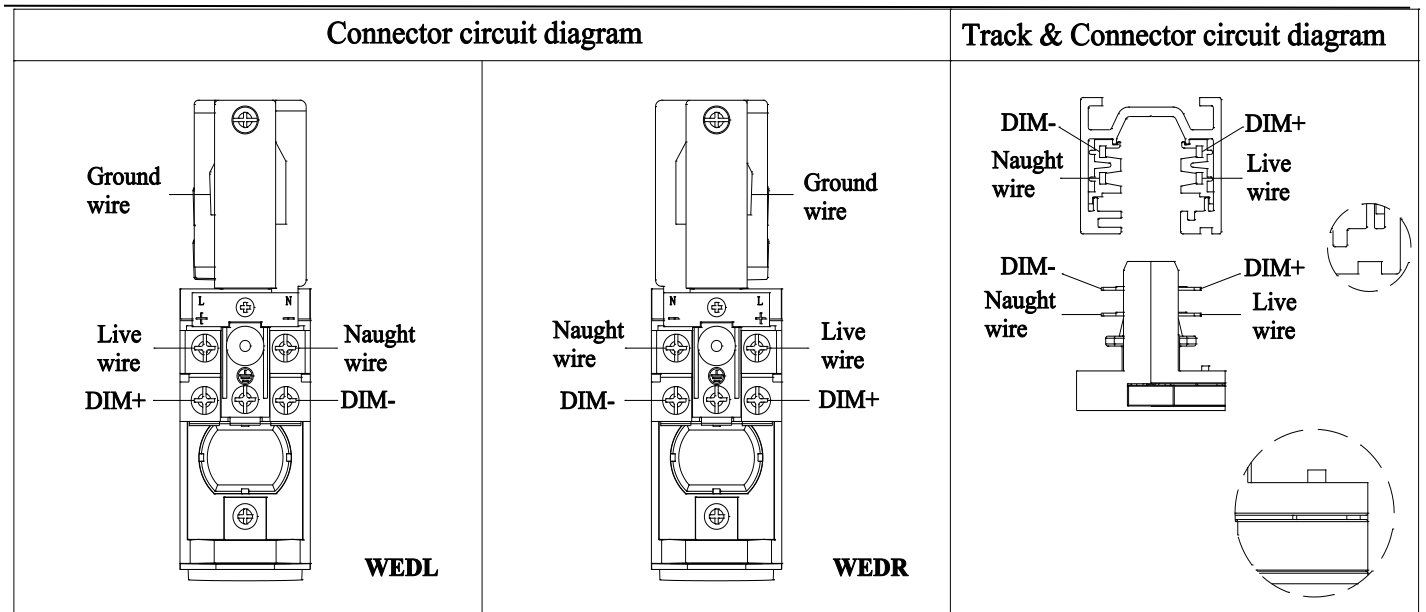

MERE- MODEL: ATL38SLD

WAC LIGHTING

W Track Luminaires

PROJECT :

TYPE :



Line Drawing

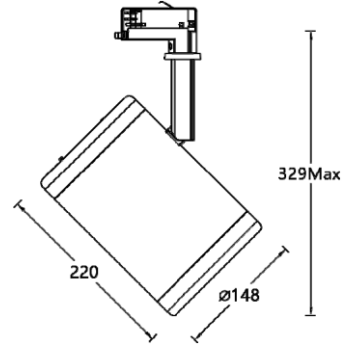

Product Description

The MERE series LED track spotlights have a modular design and are suitable for W track systems. The design of the lamp is exquisite, there is no visible radiator, and the lamp body is made of die-cast aluminum. With multi-particle HP LED light module, it can provide a rich beam Angle configuration, and more importantly, different beam Angle accessories can be changed by hand in the field, which can be used for key lighting or environmental lighting. The built-in light fixture has no strobe drive, and the dimming module can also be replaced in different ways on the spot, which is widely used in museums, art galleries, commercial Spaces, hotels, retail stores and other places.

Product Features

- Body Material: Aluminum alloy die-cast lamp body
- Optical System: Lens + reflector
- Finish: Electrostatic Powder coating, Black (BK), White (WT)
- Adjustable Angle: Horizontal 0 ~365 °, Vertical 0 ~90 °
- Accessories/Brackets: Refer to the accessories list, each type of accessories can only be added one
- Certification: CCC/CE
- IP Rating: IP20
- Insulation Level: Class I
- Operating Temperature: -20°C~40°C
- Net Weight: 0.1.8Kg without packing

Product Specifications

- LED Type: HP LED
- LED Power: 32W/48W, built-in power shift
- Source Lm: 2700K: 3080lm(18W)/4600lm(27W)
3000K: 3200lm(18W)/4800lm(27W)
3500K: 3280lm(18W)/4940lm(27W)
4000K: 3400lm(18W)/5150lm(27W)
- LED Lifetime: >50000h-L70 /B10-Ta25°C (LM-80/TM-21)
- CCT/CRI: 2700K/3000K/3500K/4000K, Ra90 or Ra97(> 95)
- SDCM: 2SDCM
- Input: 220V~240V AC/50Hz
- Dimming: On-board &0-10V, DALI(A match test is required)

Order Model

Model	LED	Dimming	Beam	CRI	CCT	Finish
ATL38S MERE	LD32 LED 32W LD48 LED 48W	D 0-10V&On-board A DALI	S 6°	9 90 A 97	27 2700K 30 3000K 35 3500K 40 4000K	WT White BK Black
			N 10°			
			1 15°			
			2 24°			
			3 36°			
			5 50°			
			E 10*50°			
			G 25*55°			
W Wash						
ATL38S	LD48	D	2	9	30	WT

























Example : ATL38SLD48-D2930WT

W Track Luminaires

PROJECT :

TYPE :

Accessories

First class fittings	Lens "Angle S"  LENS-ATL38-HSBK	Lens "Angle N"  LENS-ATL38-HNBK	Lens "Angle 1"  LENS-ATL38-H1BK	Lens "Angle 2"  LENS-ATL38-H2BK	Lens "Angle 3"  LENS-ATL38-H3BK
	Lens "Angle 5"  LENS-ATL38-H5BK	Lens "Angle E"  LENS-ATL38-HEBK	Lens "Angle G"  LENS-ATL38-HGBK		
Second class fittings	Flat lens "wall washing"  LENS-ATL38-WWWT	Flat lens "stretching"  LENS-ATL38-EEWT	Flat lens "Weak mixed light"  LENS-ATL38-SSWT	Flat lens "Medium mixed light"  LENS-ATL38-MMWT	Flat lens "Strong mixed light"  LENS-ATL38-LLWT
Third class fittings	Filters "nostalgia"  LENS-ATL38-HSWT		Filters "identifiability"  LENS-ATL38-RGWT		Filters "preference"  LENS-ATL38-PFWT
Fourth class fittings	Rimmed honeycomb  LENS-ATL38-HCM	All black condenser  White outside and black inside condenser  LENS-ATL38-SNOOT-B LENS-ATL38-SNOOT-W			
Fifth class fittings	Black four-leaf shade  LENS-ATL38-BD-BK	White four-leaf shade  LENS-ATL38-BD-WT			
Sixth class fittings	On-board &0~10V Dimmer module (black)  PART-ATL38-D-BK	On-board &0~10V Dimming module (white)  PART-ATL38-D-WT	DALI Dimmer module (Black)  PART-ATL38-A-BK	DALI Dimmer Module (White)  PART-ATL38-A-WT	

Note: Up to six types of accessories can be installed, and each type of accessories can be installed at most one at the same time

Track connection diagram

