

VOLTA - MODEL: ADDT21

WAC LIGHTING

2" Round Recessed Adjustable Downlight

PROJECT:

TYPE:

Product Image



Line Drawing

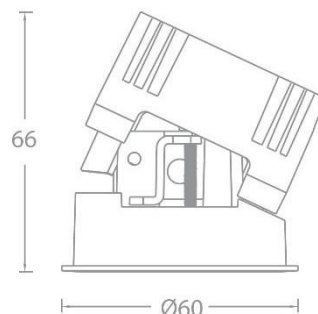

Product Description

VOLTA series LED round narrow-edge recessed angle downlights have a streamlined appearance and adopt precise lens and black mirror reflector designs to ensure that the light is emitted while still achieving the ultimate anti-glare effect. The light source cavity adopts a sealed design, which can minimize the impact of humid environment on its performance, and the reflector or optical accessories can be freely disassembled and replaced, which greatly improves on-site convenience and is mainly suitable for hotels and commercial indoor places.

Product Features

- Body Material: Aluminum alloy die-casting
- Optical System: Lens+ SUBOROSA optical system
- Finish: Static electricity powder coating
- Adjustable Angle: 0-25 ° tilt
- Accessories: As attached
- Certification: CCC
- IP Rating: IP20(Light source cavity IP44)
- Insulation Level: Class II
- Operating Temperature: -20°C~40°C

Product Specifications

- Cut-out: Ø55mm
- Ceiling Thickness: 1mm~15mm
- Shielding Angle: 30 °
- LED Type: HP LED
- Source Lm: 2700K: 682 lm;3000K: 720 lm;3500K: 752 lm; 4000K: 765 lm;5000K: 774 lm
- LED Lifetime: >50000h-L70 /B10-Ta25°C(LM-80/TM-21)
- CCT/CRI: 2700K/3000K/3500K/4000K/5000K, Ra90
- Input: 220V AC / 50Hz
- Dimming: ON-OFF / 0-10V /DALI
- Net Weight: 0.2Kg without packing

Order Model

| Model | Size | Trim | LED | Driver | Beam | CCT | Reflector | Finish |
|---|---------|-----------------|--------------------|--------------------|--------|-----------------|-------------------------------------|------------------------------------|
| ADDT Downlight Directional T series | 2 2" | 1 Round Trim | LD08 LED 8W | E ON-OFF | 1 15 ° | 27 2700K | B Black S Specular | WT White BK Black |
| | | | | D 0-10V | 2 24 ° | 30 3000K | | |
| | | | | N NO DRIVER | 3 36 ° | 35 3500K | | |
| | | | | A DALI | 5 50 ° | 40 4000K | | |
| | | | | | | 50 5000K | | |

Example: ADDT21-LD08E230SWT

VOLTA - MODEL: ADDT21
2" Round Recessed Adjustable Downlight

WAC LIGHTING

PROJECT:

TYPE:

Accessories

LENS-ADLT21-BEL
 Striped glass lens



LENS-ADLT21-HCL
 Honeycomb



Note: A maximum of one optical accessory can be installed. The accessories are not shipped from the factory and need to be ordered separately.

LIGHT DISTRIBUTION@3000K LUMINAIRE DATA

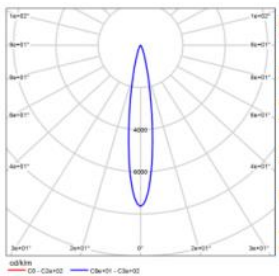

MODEL: ADDT21-LD08E130SWT
BEAM ANGLE: 15 °
POWER: 10W
LUMENS: 397lm
CBCP: 3074cd
EFFICACY: 40lm/W

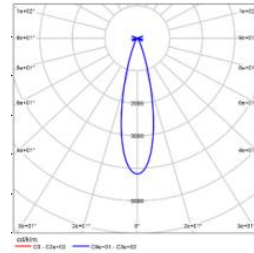

MODEL: ADDT21-LD08E230SWT
BEAM ANGLE: 24 °
POWER: 10W
LUMENS: 455lm
CBCP: 1795cd
EFFICACY: 46lm/W

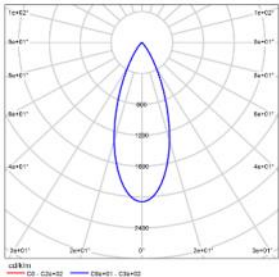

MODEL: ADDT21-LD08E330SWT
BEAM ANGLE: 36 °
POWER: 10W
LUMENS: 445lm
CBCP: 1005cd
EFFICACY: 45lm/W

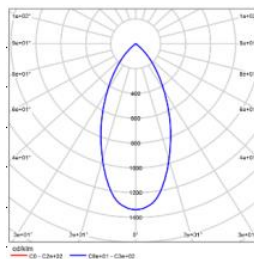

MODEL: ADDT21-LD08E530SWT
BEAM ANGLE: 50 °
POWER: 10W
LUMENS: 302lm
CBCP: 426cd
EFFICACY: 30lm/W

VOLTA - MODEL: ADDT31
3" Round Recessed Adjustable Downlight

WAC LIGHTING

PROJECT:

TYPE:

Product Image



Line Drawing

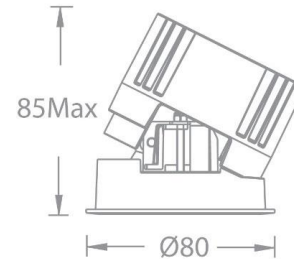

Product Description

VOLTA series LED round narrow-edge recessed angle downlights have a streamlined appearance and adopt precise lens and black mirror reflector designs to ensure that the light is emitted while still achieving the ultimate anti-glare effect. The light source cavity adopts a sealed design, which can minimize the impact of humid environment on its performance, and the reflector or optical accessories can be freely disassembled and replaced, which greatly improves on-site convenience and is mainly suitable for hotels and commercial indoor places.

Product Features

- Body Material: Aluminum alloy die-casting
- Optical System: Lens+ SUBOROSA optical system
- Finish: Static electricity powder coating
- Adjustable Angle: 0-25 ° tilt
- Accessories: As attached
- Certification: CCC
- IP Rating: IP20(Light source cavity IP44)
- Insulation Level: Class II
- Operating Temperature: -20°C~40°C

Product Specifications

- Cut-out: Ø75mm
- Ceiling Thickness: 1mm~15mm
- Shielding Angle: 30 °
- LED Type: COB
- Source Lm:
 - 2700K: 8W 682lm; 7W 758lm; 10W 1080lm; 13W 1404lm
 - 3000K: 8W 720lm; 7W 800lm; 10W 1150lm; 13W 1495lm
 - 3500K: 8W 752lm; 7W 835lm; 10W 1195lm; 13W 1554lm
 - 4000K: 8W 765lm; 7W 850lm; 10W 1210lm; 13W 1573lm
 - 5000K: 8W 774lm; 7W 860lm; 10W 1220lm; 13W 1586lm
- LED Lifetime: >50000h-L70 /B10-Ta25°C(LM-80/TM-21)
- CCT/CRI: 2700K/3000K/3500K/4000K/5000K, Ra90
- Input: 220V AC / 50Hz
- Dimming: ON-OFF / 0-10V /DALI
- Net Weight: 0.35Kg without packing

Order Model

| Model | Size | Trim | LED | Driver | Beam | CCT | Reflector | Finish |
|---|---------|-----------------|-----------------------|---------------------|----------|----------|-----------------------|----------------------|
| ADDT Downlight Directional T series | 3 3" | 1 Round Trim | LM08 LED 8W | E ON-OFF D 0-10V | S 8° | 27 2700K | B Black S Specular | WT White BK Black |
| | | | LM07 COB 7W | | 1 15° | 30 3000K | | |
| | | | LM10 COB 10W | | 2 24° | 35 3500K | | |
| | | | LM13 COB 13W | | 3 36° | 40 4000K | | |
| | | | LM13 COB 13W | 5 50° | 50 5000K | | | |
| | | | N NO DRIVER A DALI | | | | | |

Example: ADDT31-LM13E230SWT

VOLTA - MODEL: ADDT31

3" Round Recessed Adjustable Downlight

WAC LIGHTING

PROJECT:

TYPE:

Accessories

LENS-ADLT31-BEL
Striped glass lens



LENS-ADLT31-HCL
Honeycomb



Note: A maximum of one optical accessory can be installed. The accessories are not shipped from the factory and need to be ordered separately.

LIGHT DISTRIBUTION@3000K LUMINAIRE DATA

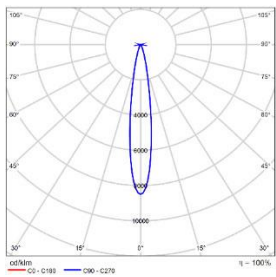

MODEL: ADDT31-LM07E130SWT
BEAM ANGLE: 15 °
POWER: 8W
LUMENS: 438lm
CBCP: 3725cd
EFFICACY: 55lm/W

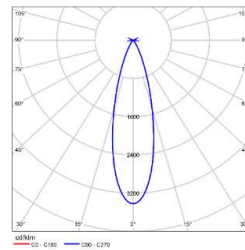

MODEL: ADDT31-LM07E230SWT
BEAM ANGLE: 24 °
POWER: 8W
LUMENS: 554lm
CBCP: 1894cd
EFFICACY: 69lm/W

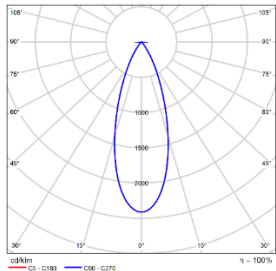

MODEL: ADDT31-LM07E330SWT
BEAM ANGLE: 36 °
POWER: 8W
LUMENS: 456lm
CBCP: 1001cd
EFFICACY: 57lm/W

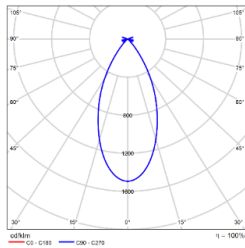

MODEL: ADDT31-LM07E530SWT
BEAM ANGLE: 50 °
POWER: 8W
LUMENS: 378lm
CBCP: 565cd
EFFICACY: 47lm/W

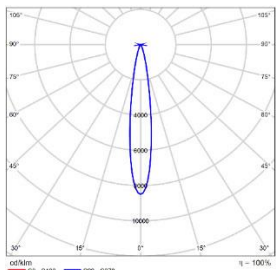

MODEL: ADDT31-LM10E130SWT
BEAM ANGLE: 15 °
POWER: 11W
LUMENS: 542lm
CBCP: 4604cd
EFFICACY: 49lm/W

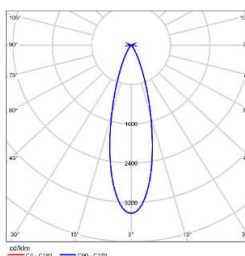

MODEL: ADDT31-LM10E230SWT
BEAM ANGLE: 24 °
POWER: 11W
LUMENS: 685lm
CBCP: 2341cd
EFFICACY: 62lm/W

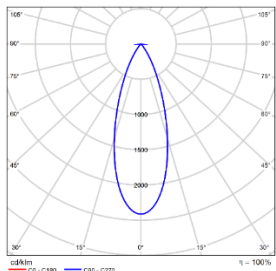

MODEL: ADDT31-LM10E330SWT
BEAM ANGLE: 36 °
POWER: 11W
LUMENS: 564lm
CBCP: 1361cd
EFFICACY: 51lm/W

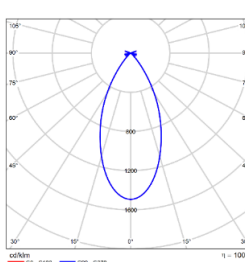

MODEL: ADDT31-LM10E530SWT
BEAM ANGLE: 50 °
POWER: 11W
LUMENS: 467lm
CBCP: 698cd
EFFICACY: 42lm/W

VOLTA - MODEL: ADDT31
3" Round Recessed Adjustable Downlight

WAC LIGHTING

PROJECT:

TYPE:

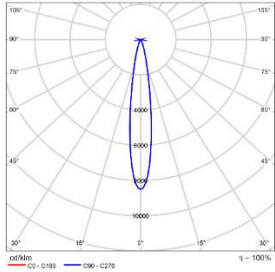

MODEL: DADT31-LM13E130SWT
BEAM ANGLE: 15 °
POWER: 15W
LUMENS: 710lm
CBCP: 6027cd
EFFICACY: 47lm/W

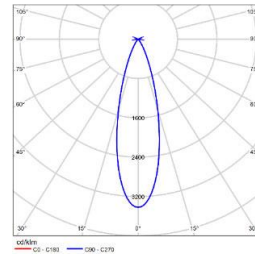

MODEL: ADDT31-LM13E230SWT
BEAM ANGLE: 24 °
POWER: 15W
LUMENS: 896lm
CBCP: 3065cd
EFFICACY: 60lm/W

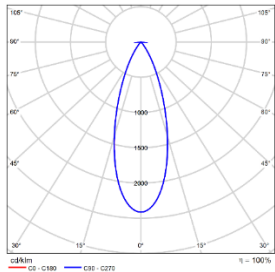

MODEL: ADDT31-LM13E330SWT
BEAM ANGLE: 36 °
POWER: 15W
LUMENS: 738lm
CBCP: 1782cd
EFFICACY: 49lm/W

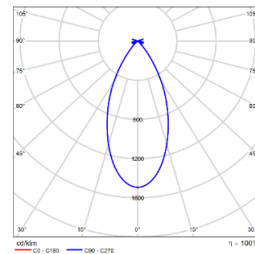

MODEL: ADDT31-LM13E530SWT
BEAM ANGLE: 50 °
POWER: 15W
LUMENS: 612lm
CBCP: 914cd
EFFICACY: 41lm/W

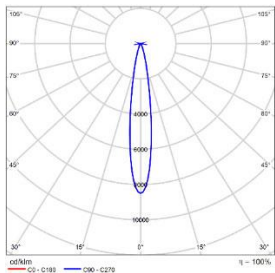

MODEL: ADDT31-LD08ES30SWT
BEAM ANGLE: 8 °
POWER: 11W
LUMENS: 375lm
CBCP: 9280cd
EFFICACY: 34lm/W