

2" Recessed Adjustable Downlight

PROJECT :

TYPE :

Product Image



Line Drawing

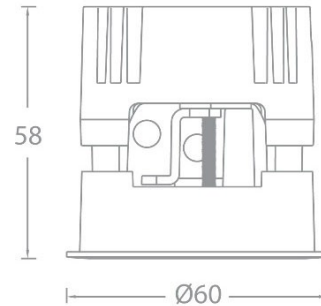

Product Description

VOLTA series LED round narrow-edge recessed angle downlights have a streamlined appearance and adopt precise lens and black mirror reflector designs to ensure that the light is emitted while still achieving the ultimate anti-glare effect. The light source cavity adopts a sealed design, which can minimize the impact of humid environment on its performance, and the reflector or optical accessories can be freely disassembled and replaced, which greatly improves on-site convenience and is mainly suitable for hotels and commercial indoor places.

Product Features

- Body Material: Aluminum alloy die-casting
- Optical System: Lens+ SUBOROSA optical system
- Finish: Static electricity powder coating
- Adjustable Angle: 0-25° tilt
- Accessories: As attached
- Certification: CCC/CE
- IP Rating: IP20(Light source cavity IP44)
- Insulation Level: Class II
- Operating Temperature: -20°C~40°C

Product Specifications

- Cut-out: Ø55
- Ceiling Thickness: 1mm~15mm
- Shielding Angle: 30°
- LED Type: HP LED
- Source Lm: 2700K 682LM; 3000K 720LM; 3500K 752LM; 4000K 765LM; 5000K 774LM;
- LED Lifetime: >50000h-L70 /B10-Ta25°C(LM-80/TM-21)
- CCT/CRI: 2700K/
3000K/3500K/4000K/5000K , Ra90
- SDCM: 3 SDCM (4000K 5SDCM)
- Input: 220V~240V AC / 50Hz
- Dimming: On-off / 0-10V /DALI
- Net Weight: 0.2Kg without packing

Order Model

Model	Size	Trim	LED	Driver	Beam	CCT	Reflector	Finish
ADLT Downlight T series	2 2"	1 Round Trim	LD08 LED 8W	E On-Off	1 15°	27 2700K	B Black	WT White
				D 0-10V	2 24°	30 3000K	S Specular	BK Black
				Dimming	3 36°	35 3500K		
				A DALI	5 50°	40 4000K		
				N No Driver		50 5000K		



Example : ADLT21-LD08E230SWT

2" Recessed Adjustable Downlight

PROJECT :

TYPE :

Accessory

<p>LENS-ADLT21-BEL Striped glass lenses</p> 	<p>LENS-ADLT21-HCL Edge honeycomb grille</p> 
--	---

Attention: At most one optical accessory can be added, and it is not included in the factory. It needs to be ordered separately

LIGHT DISTRIBUTION@3000K LUMINAIRE DATA

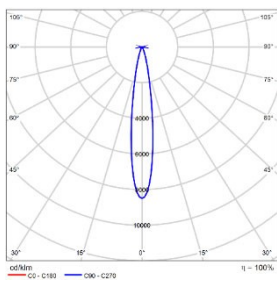

MODEL : ADLT21-LD08E130SWT
 ANGLE : 15°
 POWER : 10W
 LUMENS: 397lm
 CBCP : 3074cd
 EFFICACY : 40lm/W

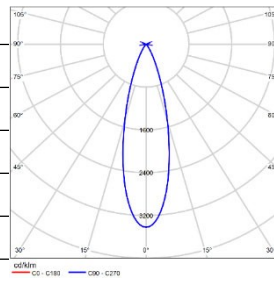

MODEL : ADLT21-LD08E230SWT
 ANGLE : 24°
 POWER : 10W
 LUMENS: 455lm
 CBCP : 1795cd
 EFFICACY : 46lm/W

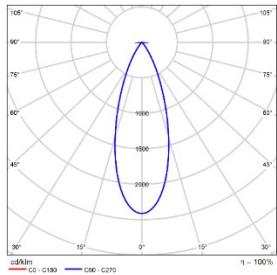

MODEL : ADLT21-LD08E330SWT
 ANGLE : 36°
 POWER : 10W
 LUMENS: 445lm
 CBCP : 1005cd
 EFFICACY : 45lm/W

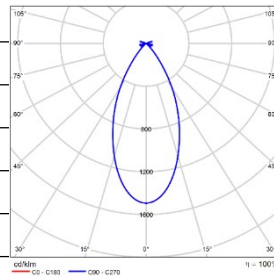

MODEL : ADLT21-LD08E530SWT
 ANGLE : 50°
 POWER : 10W
 LUMENS: 302lm
 CBCP : 426cd
 EFFICACY : 30lm/W

VOLTA— MODEL: ADLT31

WAC LIGHTING

3" Recessed Adjustable Downlight

PROJECT :

TYPE :

Product Image



Line Drawing

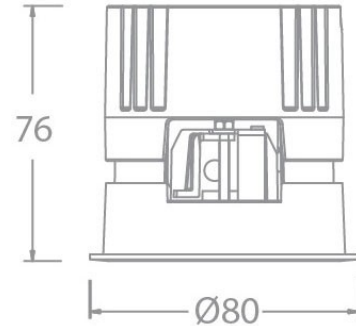

Product Description

The VOLTA series LED circular narrow edge embedded lower lighting tube lamp has a streamlined appearance and adopts precise lens and black mirror reflector design, ensuring the ultimate anti glare effect while emitting light. The light source cavity adopts a sealed design, which can minimize the impact of humid environments on its performance; Reflectors or optical accessories can also be freely disassembled and replaced, greatly improving on-site convenience, mainly suitable for hotels and commercial indoor places.

Product Features

- Body Material : Aluminum alloy die-casting
- Optical System : Lens+ SUBOROSA optical system
- Finish : Static electricity powder coating
- Adjustable Angle : /
- Accessories : As attached
- Certification : CCC
- IP Rating : IP20 (Light source cavity IP44)
- Insulation Level : Class II
- Operating Temperature : -20°C~40°C

Product Specifications

- Cut-out : Ø75mm
- Ceiling Thickness : 1mm~15mm
- Shielding Angle : 30°
- LED Type : COB
- Source Lm :
 - 2700K: 8W 682lm ; 7W 758lm; 10W 1080lm; 13W 1404lm
 - 3000K: 8W 720lm ; 7W 800lm; 10W 1150lm; 13W 1495lm
 - 3500K: 8W 752lm ; 7W 835lm; 10W 1195lm; 13W 1554lm
 - 4000K: 8W 765lm ; 7W 850lm; 10W 1210lm; 13W 1573lm
 - 5000K: 8W 774lm ; 7W 860lm; 10W 1220lm; 13W 1586lm
- LED Lifetime : >50000h-L70 /B10-Ta25°C(LM-80/TM-21)
 - CCT/CRI : 2700K/3000K/3500K/4000K/5000K , CRI≥90
 - Input : 220V AC / 50Hz
 - Dimming : Non dimming/0-10V/DALI(must be matched with the project site system in advance)
- Net Weight : 0.35Kg without packing

Order model

Model	Size	Trim	LED	Driver	Beam	CCT	Reflector	Finish
ADLT Downlight T series	3 3"	1 Round Trim	LD08 LED 8W	E On-Off D 0-10V Dimming	S 8°	27 2700K	B Black	WT White
			LM07 COB 7W		1 15°	30 3000K	S Specular	
			LM10 COB 10W		2 24°	35 3500K		
			LM13 COB 13W		3 36°	40 4000K		
			LM13 COB 13W	N No Driver A DALI	5 50°	50 5000K		

Example : ADLT31-LM13E230SWT

WAC Lighting
www.waclighting.com (US)
www.waclighting.net (International)

Headquarters
44 Harbor Park Drive • Port Washington, NY
Phone (516) 515.5000 • Fax (516) 515.5050

WAC Lighting Technology (Shanghai) Co, Ltd.
14,Lane 299, Bi Sheng Road,Shanghai 201204
Phone (86.21) 3393.3558 • Fax (86.21) 3362.1598

VOLTA- MODEL: ADLT31

3" Recessed Adjustable Downlight

PROJECT :





TYPE :

Accessory

LENS-ADLT31-BEL Striped glass lenses 	LENS-ADLT31-HCL Borderless honeycomb grille 
--	---

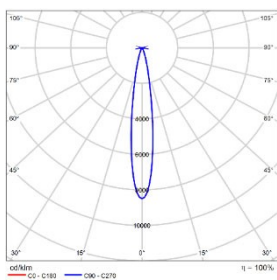
Attention: At most one optical accessory can be added, and it is not included in the factory. It needs to be ordered separately

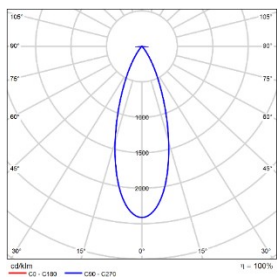
LIGHT DISTRIBUTION@3000K LUMINAIRE DATA

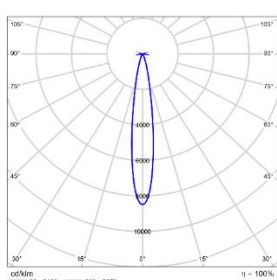
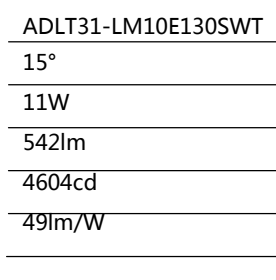
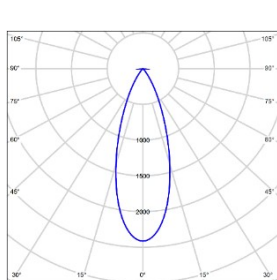
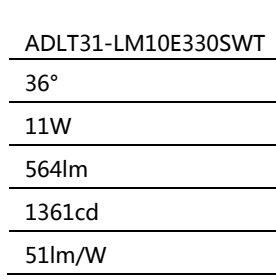
 <p>MODEL : ADLT31-LM07E130SWT ANGLE : 15° POWER : 8W LUMENS: 438lm CBCP : 3725cd EFFICACY : 55lm/W</p>	 <p>MODEL : ADLT31-LM07E230SWT ANGLE : 24° POWER : 8W LUMENS: 554lm CBCP : 1894cd EFFICACY : 69lm/W</p>
 <p>MODEL : ADLT31-LM07E330SWT ANGLE : 36° POWER : 8W LUMENS: 456lm CBCP : 1101cd EFFICACY : 57lm/W</p>	 <p>MODEL : ADLT31-LM07E530SWT ANGLE : 50° POWER : 8W LUMENS: 378lm CBCP : 565cd EFFICACY : 47lm/W</p>
 <p>MODEL : ADLT31-LM10E130SWT ANGLE : 15° POWER : 11W LUMENS: 542lm CBCP : 4604cd EFFICACY : 49lm/W</p>	 <p>MODEL : ADLT31-LM10E230SWT ANGLE : 24° POWER : 11W LUMENS: 685lm CBCP : 2341cd EFFICACY : 62lm/W</p>
 <p>MODEL : ADLT31-LM10E330SWT ANGLE : 36° POWER : 11W LUMENS: 564lm CBCP : 1361cd EFFICACY : 51lm/W</p>	 <p>MODEL : ADLT31-LM10E530SWT ANGLE : 50° POWER : 11W LUMENS: 467lm CBCP : 698cd EFFICACY : 42lm/W</p>

VOLTA- MODEL: ADLT31

WAC LIGHTING

3" Recessed Adjustable Downlight

PROJECT :

TYPE :

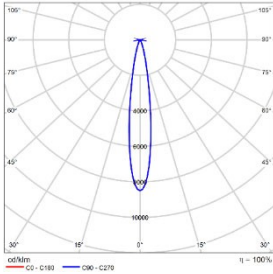

MODEL : ADLT31-LM13E130SWT
ANGLE : 15°
POWER : 15W
LUMENS: 710lm
CBCP : 6027cd
EFFICACY : 47lm/W

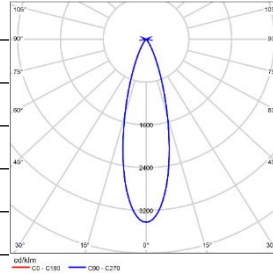

MODEL : ADLT31-LM13E230SWT
ANGLE : 24°
POWER : 15W
LUMENS: 896lm
CBCP : 3065cd
EFFICACY : 60lm/W

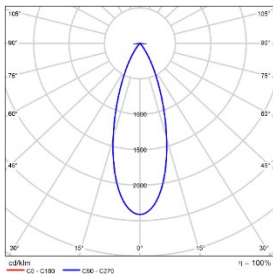

MODEL : ADLT31-LM13E330SWT
ANGLE : 36°
POWER : 15W
LUMENS: 738lm
CBCP : 1782cd
EFFICACY : 49lm/W

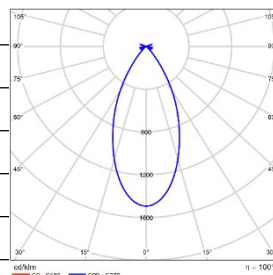

MODEL : ADLT31-LM13E530SWT
ANGLE : 50°
POWER : 15W
LUMENS: 612lm
CBCP : 914cd
EFFICACY : 41lm/W

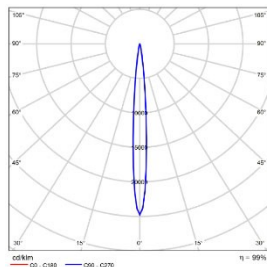

MODEL : ADLT31-LD08ES30SWT
ANGLE : 8°
POWER : 11W
LUMENS: 375lm
CBCP : 9280cd
EFFICACY : 34lm/W