

VOLTA- MODEL: ADLT41

WAC LIGHTING

4" Round Narrow Recessed Downlight

Project Name:

Type:

Product Image



Line Drawing

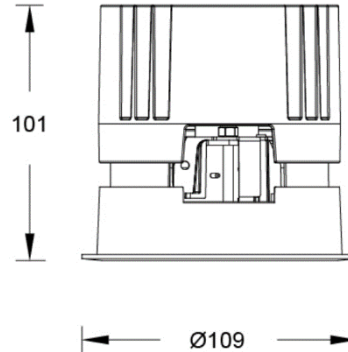

Product Description

VOLTA series LED round narrow recessed downlight, streamlined appearance, with precise lens and black mirror reflector design. It guarantees light output while still achieving the ultimate anti-glare effect, and the light source cavity is sealed to minimize the impact of humid environment on its performance. Free to remove and replace the reflector or optical accessories, greatly improving the convenience of the site. Mainly suitable for hotel and commercial indoor places.

Product Features

- **Body Material:** Aluminum die-casting lamp body
- **Optical System:** Lens+Reflector
- **Finish:** Electrostatic powder coating
- **Objection Angle:** /
- **Accessory / Bracket:** See attachment
- **Certification:** CCC
- **IP Rating:** IP20 (light source cavity IP44)
- **Insulation Class:** Class II
- **Operating Temperature:** -20°C~40°C

Product Specifications

- **Cutoff:** Ø100mm
- **Ceiling Thickness:** 1mm~20mm
- **Shading Angle:** 30°
- **LED Type:** COB
- **Source Lm:** 2700K: 8W 685lm; 13W 1380lm; 18W 1860lm
3000K: 8W 720lm; 13W 1465lm; 18W 1975lm
3500K: 8W 750lm; 13W 1540lm; 18W 2070lm
4000K: 8W 765lm; 13W 1600lm; 18W 2155lm
5000K: 8W 775lm; 13W 1645lm; 18W 2220lm
- **LED Lifetime:** >50000h-L70 /B10-Ta25°C(LM-80/TM-21)
- **CCT/CRI:** 2700K/3000K/3500K/4000K/5000K, CRI≥90
- **Input:** 220V AC / 50Hz
- **Dimming:** Non-dimming / 0-10V/DALI (must be done in advance with the project site system to match the test)
- **Net Weight:** Approx. 0.6Kg, without packaging

Order Model

Model	Size	Trim	LED	Driver	Beam	CCT	Reflector	Finish
ADLT Downlight T series	4"	1 Round Trim	LD08 LED 8W	E On-Off D 0-10V Dimming	S 8°	27 2700K	B Black	WT White
			LM13 COB 13W		1 15°	30 3000K	S Specular	BK Black
			LM18 COB 18W	2 24°	35 3500K			
			LM18 COB 18W	3 36°	40 4000K			
			LM18 COB 18W	N No Driver A DALI	5 50°	50 5000K		

Example: ADLT41-LM18E230SWT

WAC Lighting
www.waclighting.com (US)
www.waclighting.net (International)

Headquarters
44 Harbor Park Drive • Port Washington, NY
Phone (516) 515.5000 • Fax (516) 515.5050

WAC Lighting Technology (Shanghai) Co, Ltd.
14,Lane 299, Bi Sheng Road,Shanghai 201204
Phone (86.21) 3393.3558 • Fax (86.21) 3362.1598

VOLTA- MODEL: ADLT41

4" Round Narrow Recessed Downlight

WAC LIGHTING

Project Name:

Type:

Accessory

LENS-ADLT41-BEL Striped Glass Lens		LENS-ADLT41-HCL Rimless Honeycomb Grid	
--	---	--	---

Note: Up to one additional optical accessory can be installed, the factory does not come with accessories, need to be ordered separately.

Light Distribution@3000K Data

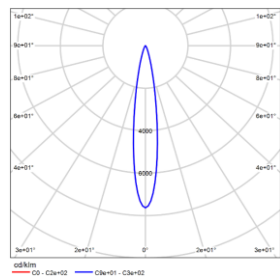
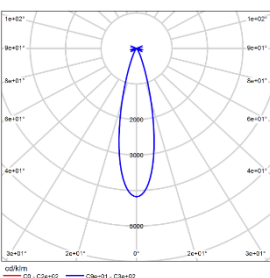
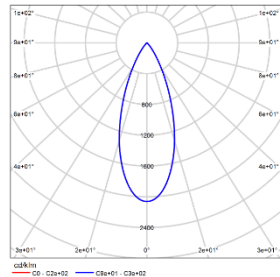
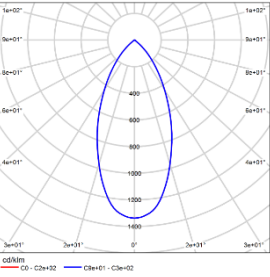
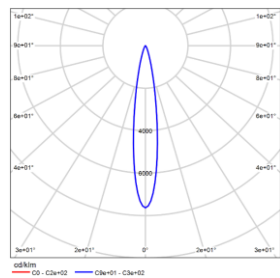
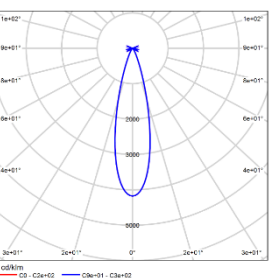
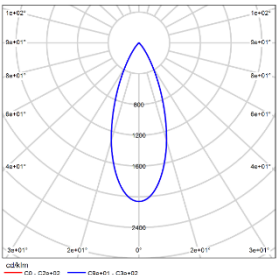
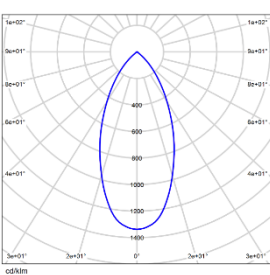
	<p>MODEL: ADLT41-LM13E130SWT</p> <p>BEAM ANGLE: 15°</p> <p>POWER: 15W</p> <p>LUMENS: 884lm</p> <p>CBCP: 6749cd</p> <p>EFFICACY: 59lm/W</p>		<p>MODEL: ADLT41-LM13E230SWT</p> <p>BEAM ANGLE: 24°</p> <p>POWER: 15W</p> <p>LUMENS: 1128lm</p> <p>CBCP: 4708cd</p> <p>EFFICACY: 75lm/W</p>
	<p>MODEL: ADLT41-LM13E330SWT</p> <p>BEAM ANGLE: 36°</p> <p>POWER: 15W</p> <p>LUMENS: 1204lm</p> <p>CBCP: 2482cd</p> <p>EFFICACY: 80lm/W</p>		<p>MODEL: ADLT41-LM13E530SWT</p> <p>BEAM ANGLE: 50°</p> <p>POWER: 15W</p> <p>LUMENS: 995lm</p> <p>CBCP: 1330cd</p> <p>EFFICACY: 66lm/W</p>
	<p>MODEL: ADLT41-LM18E130SWT</p> <p>BEAM ANGLE: 15°</p> <p>POWER: 22W</p> <p>LUMENS: 1258lm</p> <p>CBCP: 9597cd</p> <p>EFFICACY: 57lm/W</p>		<p>MODEL: ADLT41-LM18E230SWT</p> <p>BEAM ANGLE: 24°</p> <p>POWER: 21W</p> <p>LUMENS: 1604lm</p> <p>CBCP: 6695cd</p> <p>EFFICACY: 76lm/W</p>
	<p>MODEL: ADLT41-LM18E330SWT</p> <p>BEAM ANGLE: 36°</p> <p>POWER: 21W</p> <p>LUMENS: 1712lm</p> <p>CBCP: 3529cd</p> <p>EFFICACY: 82lm/W</p>		<p>MODEL: ADLT41-LM18E530SWT</p> <p>BEAM ANGLE: 50°</p> <p>POWER: 21W</p> <p>LUMENS: 1414lm</p> <p>CBCP: 1891cd</p> <p>EFFICACY: 67lm/W</p>

WAC Lighting
www.waclighting.com (US)
www.waclighting.net (International)

Headquarters
 44 Harbor Park Drive • Port Washington, NY
 Phone (516) 515.5000 • Fax (516) 515.5050

WAC Lighting Technology (Shanghai) Co, Ltd.
 14, Lane 299, Bi Sheng Road, Shanghai 201204
 Phone (86.21) 3393.3558 • Fax (86.21) 3362.1598

WAC Lighting reserves the right to periodically design and update products. 2024-03-26

VOLTA- MODEL: ADLT41

WAC LIGHTING

4" Round Narrow Recessed Downlight

Project Name:

Type:

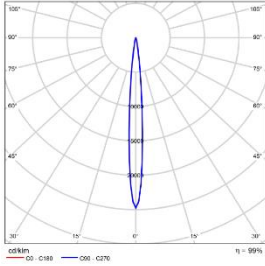

MODEL: ADLT41-LD08ES30SWT

BEAM ANGLE: 8°

POWER: 11W

LUMENS: 375lm

CBCP: 9280cd

EFFICACY: 34lm/W

VOLTA- MODEL: ADLT51

WAC LIGHTING

5" Round Narrow Recessed Downlight

Project Name:

Type:

Product Image



Line Drawing

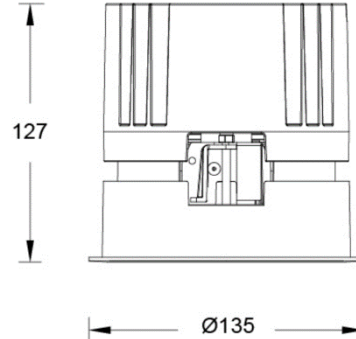

Product Description

VOLTA series LED round narrow recessed downlight, streamlined appearance, with precise lens and black mirror reflector design. It guarantees light output while still achieving the ultimate anti-glare effect, and the light source cavity is sealed to minimize the impact of humid environment on its performance. Free to remove and replace the reflector or optical accessories, greatly improving the convenience of the site. Mainly suitable for hotel and commercial indoor places.

Product Features

- **Body Material:** Aluminum die-casting lamp body
- **Optical System:** Lens+Reflector
- **Finish:** Electrostatic powder coating
- **Objection Angle:** /
- **Accessory / Bracket:** See attachment
- **Certification:** CCC
- **IP Rating:** IP20 (light source cavity IP44)
- **Insulation Class:** Class II
- **Operating Temperature:** -20°C~40°C

Product Specifications

- **Cutoff:** Ø125mm
- **Ceiling Thickness:** 1mm~25mm
- **Shading Angle:** 30°
- **LED Type:** COB (of which 8° is HP LED)
- **Source Lm:**
2700K: 24W 2055lm; 18W 1860lm; 25W 2460lm; 32W 3065lm
3000K: 24W 2160lm; 18W 1975lm; 25W 2610lm; 32W 3255lm
3500K: 24W 2250lm; 18W 2070lm; 25W 2710lm; 32W 3380lm
4000K: 24W 2295lm; 18W 2155lm; 25W 2790lm; 32W 3480lm
5000K: 24W 2325lm; 18W 2220lm; 25W 2870lm; 32W 3580lm
- **LED Lifetime:** >50000h-L70 /B10-Ta25°C(LM-80/TM-21)
- **CCT/CRI:** 2700K/3000K/3500K/4000K/5000K, CRI≥90
- **Input:** 220V AC / 50Hz
- **Dimming:** No dimming / 0-10V/DALI (must do match test with project site system in advance) .
- **Net Weight:** Approx. 1.0Kg, excluding packaging

Order Model

Model	Size	Trim	LED	Driver	Beam	CCT	Reflector	Finish
ADLT Downlight T series	5"	1 Round Trim	LD24 LED 24W	E On-Off D 0-10V Dimming	S 8°	27 2700K	B Black	WT White
			LM18 COB 18W		1 15°	30 3000K	S Specular	
			LM25 COB 25W		2 24°	35 3500K		
			LM32 COB 32W	3 36°	40 4000K			
			LM32 COB 32W	5 50°	50 5000K	N No Driver A DALI		

Example: ADLT51-LM25E230SWT

WAC Lighting
www.waclighting.com (US)
www.waclighting.net (International)

Headquarters
44 Harbor Park Drive • Port Washington, NY
Phone (516) 515.5000 • Fax (516) 515.5050

WAC Lighting Technology (Shanghai) Co, Ltd.
14,Lane 299, Bi Sheng Road,Shanghai 201204
Phone (86.21) 3393.3558 • Fax (86.21) 3362.1598

VOLTA- MODEL: ADLT51

WAC LIGHTING

5" Round Narrow Recessed Downlight

Project Name:

Type:

Accessory

LENS-ADLT51-BEL Striped Glass Lens 	LENS-ADLT51-HCL Rimless Honeycomb Grid 
--	--

Note: Up to one additional optical accessory can be installed, the factory does not come with accessories, need to be ordered separately.

Light Distribution@3000K Data

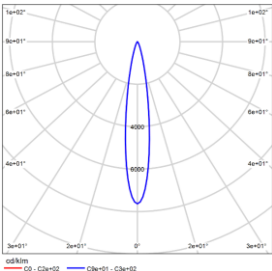
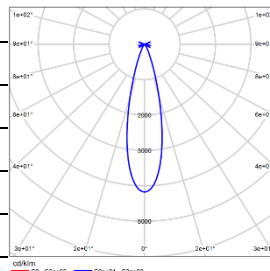
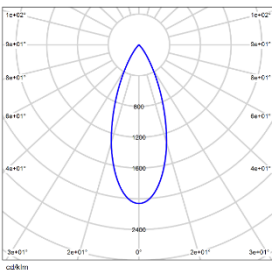
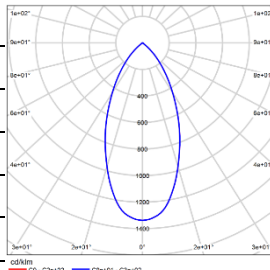
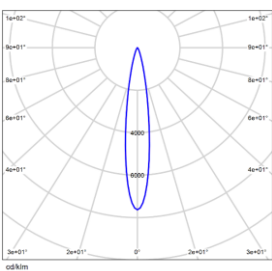
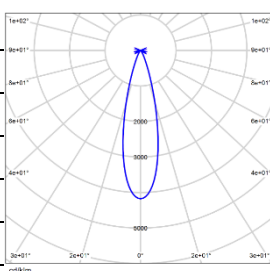
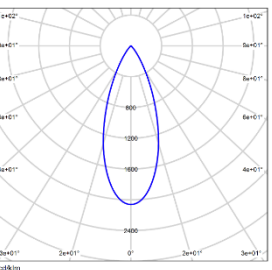
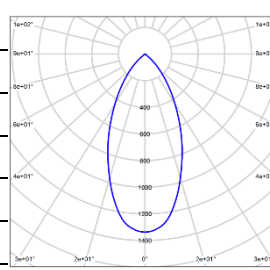
	MODEL: ADLT51-LM18E130SWT BEAM ANGLE: 15° POWER: 21W LUMENS: 1609lm CBCP: 14044cd EFFICACY: 77lm/W		MODEL: ADLT51-LM18E230SWT BEAM ANGLE: 24° POWER: 21W LUMENS: 1640lm CBCP: 6742cd EFFICACY: 78lm/W
	MODEL: ADLT51-LM18E330SWT BEAM ANGLE: 36° POWER: 21W LUMENS: 1783lm CBCP: 3738cd EFFICACY: 85lm/W		MODEL: ADLT51-LM18E530SWT BEAM ANGLE: 50° POWER: 21W LUMENS: 1538lm CBCP: 2311cd EFFICACY: 73lm/W
	MODEL: ADLT51-LM25E130SWT BEAM ANGLE: 15° POWER: 28W LUMENS: 2111lm CBCP: 18431cd EFFICACY: 75lm/W		MODEL: ADLT51-LM25E230SWT BEAM ANGLE: 24° POWER: 28W LUMENS: 2152lm CBCP: 8848cd EFFICACY: 77lm/W
	MODEL: ADLT51-LM25E330SWT BEAM ANGLE: 36° POWER: 28W LUMENS: 2340lm CBCP: 4905cd EFFICACY: 84lm/W		MODEL: ADLT51-LM25E530SWT BEAM ANGLE: 50° POWER: 28W LUMENS: 2018lm CBCP: 3033cd EFFICACY: 72lm/W

VOLTA- MODEL: ADLT51

WAC LIGHTING

5" Round Narrow Recessed Downlight

Project Name:

Type:

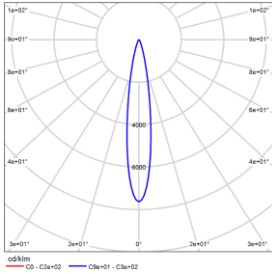

MODEL: ADLT51-LM32E130SWT
BEAM ANGLE: 15°
POWER: 35W
LUMENS: 2630lm
CBCP: 22965cd
EFFICACY: 75lm/W

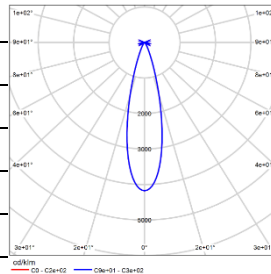

MODEL: ADLT51-LM32E230SWT
BEAM ANGLE: 24°
POWER: 35W
LUMENS: 2682lm
CBCP: 11024cd
EFFICACY: 77lm/W

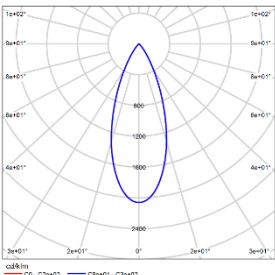

MODEL: ADLT51-LM32E330SWT
BEAM ANGLE: 36°
POWER: 35W
LUMENS: 2916lm
CBCP: 6112cd
EFFICACY: 83lm/W

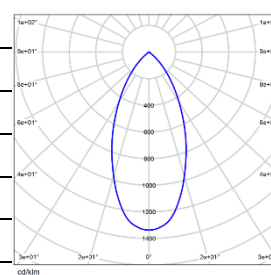

MODEL: ADLT51-LM32E530SWT
BEAM ANGLE: 50°
POWER: 35W
LUMENS: 2514lm
CBCP: 3779cd
EFFICACY: 72lm/W

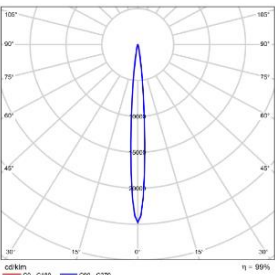

MODEL: ADLT51-LD24ES30SWT
BEAM ANGLE: 8°
POWER: 28W
LUMENS: 1125lm
CBCP: 27840cd
EFFICACY: 40lm/W

VOLTA- MODEL: ADLT61

WAC LIGHTING

6" Round Narrow Recessed Downlight

Project Name:

Type:

Product Image



Line Drawing

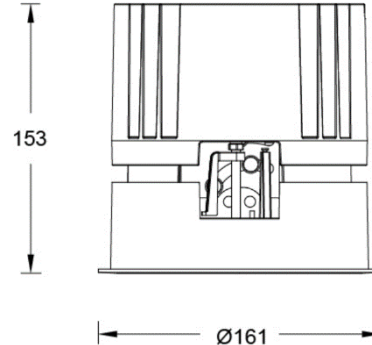

Product Description

VOLTA series LED round narrow recessed downlight, streamlined appearance, with precise lens and black mirror reflector design. It guarantees light output while still achieving the ultimate anti-glare effect, and the light source cavity is sealed to minimize the impact of humid environment on its performance. Free to remove and replace the reflector or optical accessories, greatly improving the convenience of the site. Mainly suitable for hotel and commercial indoor places.

Product Features

- **Body Material:** Aluminum die-casting lamp body
- **Optical System:** Lens+Reflector
- **Finish:** Electrostatic powder coating
- **Objection Angle:** /
- **Accessory / Bracket:** See attachment
- **Certification:** CCC
- **IP Rating:** IP20 (light source cavity IP44)
- **Insulation Class:** Class II
- **Operating Temperature:** -20°C~40°C

Product Specification

- **Cutoff:** Ø150mm
- **Ceiling Thickness:** 1mm~30mm
- **Shading Angle:** 30°
- **LED Type:** COB (of which 8° is HP LED)
- **Source Lm**
2700K: 32W 2740lm; 32W 3610lm; 43W 4250lm
3000K: 32W 2880lm; 32W 3830lm; 43W 4505lm
3500K: 32W 3000lm; 32W 4020lm; 43W 4730lm
4000K: 32W 3060lm; 32W 4180lm; 43W 4920lm
5000K: 32W 3100lm; 32W 4310lm; 43W 5065lm
- **LED Lifetime:** >50000h-L70 /B10-Ta25°C(LM-80/TM-21)
- **CCT/CRI:** 2700K/3000K/3500K/4000K/5000K, CRI≥90
- **Input:** 220V AC / 50Hz
- **Dimming:** No dimming / 0-10V/DALI (must do match test with project site system in advance) .
- **Net Weight:** Approx. 1.7Kg, excluding packaging

Order Model

Model	Size	Trim	LED	Driver	Beam	CCT	Reflector	Finish
ADLT Downlight T series	6 6"	1 Round Trim	LD32 LED 32W	E On-Off	S 8°	27 2700K	B Black	WT White
			LM32 COB 32W	D 0-10V	1 15°	30 3000K	S Specular	BK Black
			LM43 COB 43W	Dimming	2 24°	35 3500K		
			LM43 COB 43W	N No Driver	3 36°	40 4000K		
				A DALI	5 50°	50 5000K		

Example: ADLT61-LM43E230SWT

WAC Lighting
www.waclighting.com (US)
www.waclighting.net (International)

Headquarters
44 Harbor Park Drive • Port Washington, NY
Phone (516) 515.5000 • Fax (516) 515.5050

WAC Lighting Technology (Shanghai) Co, Ltd.
14,Lane 299, Bi Sheng Road,Shanghai 201204
Phone (86.21) 3393.3558 • Fax (86.21) 3362.1598

VOLTA- MODEL: ADLT61

WAC LIGHTING

6" Round Narrow Recessed Downlight

Project Name:

Type:

Accessory

LENS-ADLT61-BEL Striped Glass Lens		LENS-ADLT61-HCL Rimless Honeycomb Grid	
--	---	--	---

Note: Up to one additional optical accessory can be installed, the factory does not come with accessories, need to be ordered separately.

Light Distribution@3000K Data

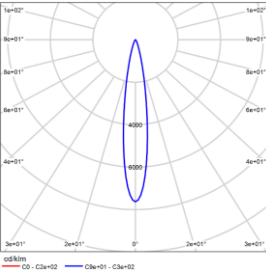
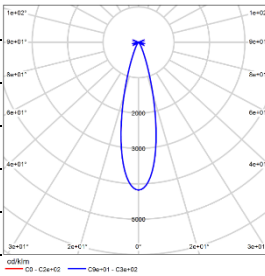
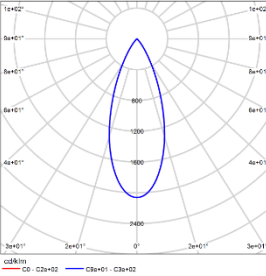
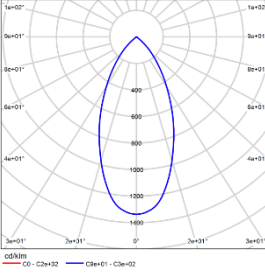
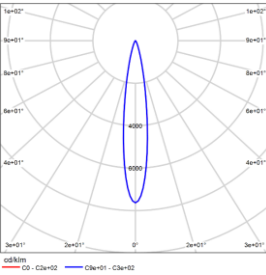
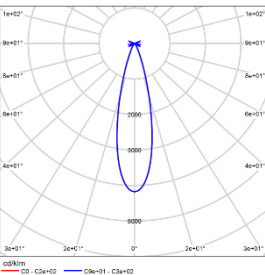
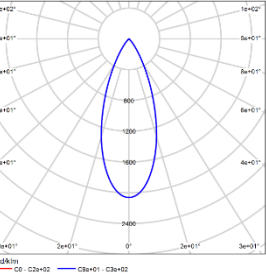
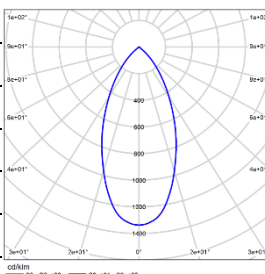
	<p>MODEL: ADLT61-LM32E130SWT</p> <p>BEAM ANGLE: 15°</p> <p>POWER: 35W</p> <p>LUMENS: 2393lm</p> <p>CBCP: 23635cd</p> <p>EFFICACY: 68lm/W</p>		<p>MODEL: ADLT61-LM32E230SWT</p> <p>BEAM ANGLE: 24°</p> <p>POWER: 35W</p> <p>LUMENS: 3015lm</p> <p>CBCP: 13170cd</p> <p>EFFICACY: 86lm/W</p>
	<p>MODEL: ADLT61-LM32E330SWT</p> <p>BEAM ANGLE: 36°</p> <p>POWER: 35W</p> <p>LUMENS: 3001lm</p> <p>CBCP: 6651cd</p> <p>EFFICACY: 86lm/W</p>		<p>MODEL: ADLT61-LM32E530SWT</p> <p>BEAM ANGLE: 50°</p> <p>POWER: 35W</p> <p>LUMENS: 2830lm</p> <p>CBCP: 3762cd</p> <p>EFFICACY: 81lm/W</p>
	<p>MODEL: ADLT61-LM43E130SWT</p> <p>BEAM ANGLE: 15°</p> <p>POWER: 47W</p> <p>LUMENS: 3108lm</p> <p>CBCP: 30695cd</p> <p>EFFICACY: 66lm/W</p>		<p>MODEL: ADLT61-LM43E230SWT</p> <p>BEAM ANGLE: 24°</p> <p>POWER: 47W</p> <p>LUMENS: 3916lm</p> <p>CBCP: 17104cd</p> <p>EFFICACY: 83lm/W</p>
	<p>MODEL: ADLT61-LM43E330SWT</p> <p>BEAM ANGLE: 36°</p> <p>POWER: 47W</p> <p>LUMENS: 3897lm</p> <p>CBCP: 8638cd</p> <p>EFFICACY: 83lm/W</p>		<p>MODEL: ADLT61-LM43E530SWT</p> <p>BEAM ANGLE: 50°</p> <p>POWER: 47W</p> <p>LUMENS: 3675lm</p> <p>CBCP: 4885cd</p> <p>EFFICACY: 78lm/W</p>

VOLTA- MODEL: ADLT61

WAC LIGHTING

6" Round Narrow Recessed Downlight

Project Name:

Type:

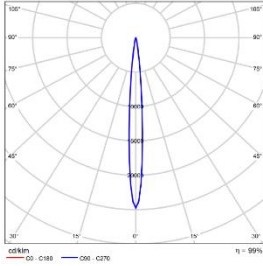

MODEL: ADLT61-LD32ES30SWT

BEAM ANGLE: 8°

POWER: 35W

LUMENS: 1500lm

CBCP: 37120cd

EFFICACY: 43lm/W