

LIGNE PRO - MODEL:OR150AL-06

Linear Luminaires

WAC LIGHTING

Responsible Lighting®

Project Name:

Type:

Product Image



Line Drawing

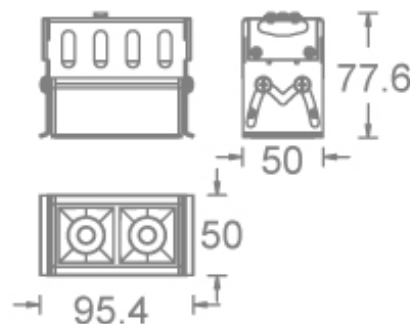

Product Description

LIGNE PRO is a recessed linear downlighting luminaire with an aluminum body. Aesthetic design with a simple and elegant exterior. It uses LED light source and the original SUBROSA anti-glare design. Various light distribution is available. It is mainly used in public space, commercial, office, display lighting and other places.

Product Features

- **Body Material:** Aluminum extruded lamp body
- **Optical System:** Lens + SUBROSA Invisible Light System
- **Finish:** Electrostatic Powder Coating
- **Adjustable Angle:** +/- 35° Adjustable
- **Accessories:** /
- **Certification:** CCC
- **IP Rating:** IP20
- **Insulation Level:** Class II
- **Operating Temperature:** -20°C~40°C

Product Specifications

- **Opening Size:** □106mm*63mm
- **Ceiling Thickness:** 5-25mm
- **Shading Angle:** 40°
- **LED Type:** High Power LED
- **Source Lm:** 2700K 726lm; 3000K 750lm; 3500K 780lm; 4000K 810lm
- **LED Lifetime:** >50000h-L70 /B10-Ta25°C(LM-80/TM-21)
- **CCT/CRI:** 2700K/3000K/3500K/4000K, Ra90
- **SDCM:** 3 SDCM
- **Input:** 220V~240V AC / 50Hz
- **Dimming:** ON-OFF/0-10V (Must conduct compatibility testing with the project site system in advance)
- **Net Weight:** Approx. 0.22Kg, excluding packaging

Order Model

Model	Comment	Power (W)	Driver	Beam	CCT	Reflector	Finish
OR150 R Recessed mounting 1 Series 50 Width	AL Adjustable Trimless	06 6W	E ON-OFF D 0-10V Dimming	1 16°	27 2700K	B Black	WT White
				3 36°	30 3000K	S Specular	
				4 46°	35 3500K	G Gold	
				40 4000K	H Haze		

Example: OR150AL-06E-140BWT

LIGNE PRO - MODEL:OR150AL-06

Linear Luminaires

WAC LIGHTING

Responsible Lighting®

Project Name:

Type:

Accessory

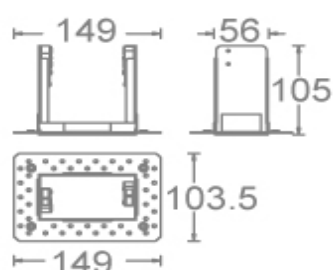
Model	Type	Dimension
OR150AL-RC002	2 Module Pre-Embedded Parts	

Light Curve Distribution @4000K Data

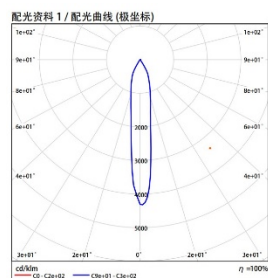

MODEL:	OR150AL-06E-140BWT
BEAM ANGLE:	16°
POWER:	6.9W
LUMENS:	612lm
CBCP:	2865
EFFICACY:	89lm/W

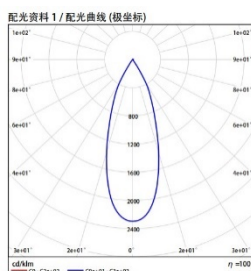

MODEL:	OR150AL-06E-340BWT
BEAM ANGLE:	36°
POWER:	6.8W
LUMENS:	612lm
CBCP:	1419
EFFICACY:	90lm/W

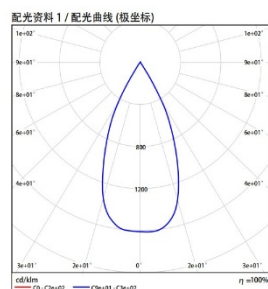

MODEL:	OR150AL-06E-440BWT
BEAM ANGLE:	46°
POWER:	6.8W
LUMENS:	612lm
CBCP:	1039
EFFICACY:	90lm/W

LIGNE PRO - MODEL:OR150AL-11

Linear Luminaires

WAC LIGHTING

Responsible Lighting®

Project Name:

Type:

Product Image



Line Drawing

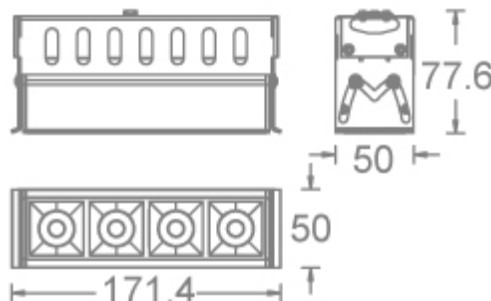

Product Description

LIGNE PRO is a recessed linear downlighting luminaire with an aluminum body. Aesthetic design with a simple and elegant exterior. It uses LED light source and the original SUBROSA anti-glare design. Various light distribution is available. It is mainly used in public space, commercial, office, display lighting and other places.

Product Features

- **Body Material:** Aluminum extruded lamp body
- **Optical System:** Lens + SUBROSA Invisible Light System
- **Finish:** Electrostatic Powder Coating
- **Adjustable Angle:** +/- 35° Adjustable
- **Accessories:** /
- **Certification:** CCC
- **IP Rating:** IP20
- **Insulation Level:** Class II
- **Operating Temperature:** -20°C~40°C

Product Specifications

- **Opening Size:** □183mm*63mm
- **Ceiling Thickness:** 5-25mm
- **Shading Angle:** 40°
- **LED Type:** High Power LED
- **Source Lm:** 2700K 1331lm; 3000K 1375lm; 3500K 1430lm; 4000K 1485lm
- **LED Lifetime:** >50000h-L70 /B10-Ta25°C(LM-80/TM-21)
- **CCT/CRI:** 2700K/3000K/3500K/4000K, Ra90
- **SDCM:** 3 SDCM
- **Input:** 220V~240V AC / 50Hz
- **Dimming:** ON-OFF/0-10V (Must conduct compatibility testing with the project site system in advance)
- **Net Weight:** Approx. 0.58Kg, excluding packaging

Order Model

Model	Comment	Power (W)	Driver	Beam	CCT	Reflector	Finish
OR150	AL Adjustable	11 11W	E ON-OFF	1 16°	27 2700K	B Black	WT White
R Recessed mounting	Trimless		D 0-10V Dimming	3 36°	30 3000K	S Specular	
1 Series				4 46°	35 3500K	G Gold	
50 Width					40 4000K	H Haze	

Example: OR150AL-11E-140BWT

Accessory

WAC Lighting
www.waclighting.com (US)
www.waclighting.com.cn (China)

Headquarters
44 Harbor Park Drive • Port Washington, NY
Phone (516) 515.5000 • Fax (516) 515.5050

WAC Lighting(Shanghai)
14,Lane 299, Bi Sheng Road,Shanghai 201204
Phone (86.21) 3393.3558 • Fax (86.21) 3362.1598

LIGNE PRO - MODEL:OR150AL-11

Linear Luminaires

WAC LIGHTING

Responsible Lighting®

Project Name:

Type:

Model	Type	Dimension
OR150AL-RC004	4 Module Pre-Embedded Parts	

Light Curve Distribution @4000K Data

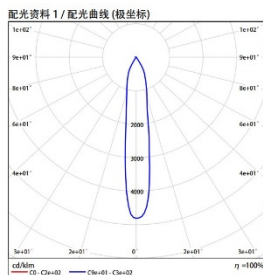

MODEL: OR150AL-11E-140BWT

BEAM ANGLE: 16°

POWER: 11.9W

LUMENS: 1227lm

CBCP: 5950

EFFICACY: 103lm/W

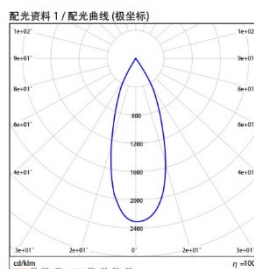

MODEL: OR150AL-11E-340BWT

BEAM ANGLE: 36°

POWER: 11.9W

LUMENS: 1231lm

CBCP: 2848

EFFICACY: 104lm/W

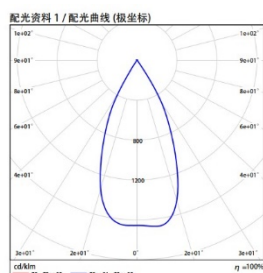

MODEL: OR150AL-11E-440BWT

BEAM ANGLE: 46°

POWER: 11.9W

LUMENS: 1240lm

CBCP: 2094

EFFICACY: 105lm/W

LIGNE PRO - MODEL:OR150AL-22

Linear Luminaires

WAC LIGHTING

Responsible Lighting®

Project Name:

Type:

Product Image



Line Drawing

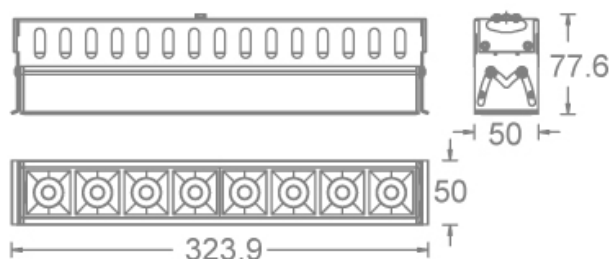

Product Description

LIGNE PRO is a recessed linear downlighting luminaire with an aluminum body. Aesthetic design with a simple and elegant exterior. It uses LED light source and the original SUBROSA anti-glare design. Various light distribution is available. It is mainly used in public space, commercial, office, display lighting and other places.

Product Features

- **Body Material:** Aluminum extruded lamp body
- **Optical System:** Lens + SUBROSA Invisible Light System
- **Finish:** Electrostatic Powder Coating
- **Adjustable Angle:** +/- 35° Adjustable
- **Accessories:** /
- **Certification:** CCC
- **IP Rating:** IP20
- **Insulation Level:** Class II
- **Operating Temperature:** -20°C~40°C

Product Specifications

- **Opening Size:** □336mm*63mm
- **Ceiling Thickness:** 5-25mm
- **Shading Angle:** 40°
- **LED Type:** High Power LED
- **Source Lm:** 2700K 2662lm; 3000K 2750lm; 3500K 2860lm; 4000K 2970lm
- **LED Lifetime:** >50000h-L70 /B10-Ta25°C(LM-80/TM-21)
- **CCT/CRI:** 2700K/3000K/3500K/4000K, Ra90
- **SDCM:** 3 SDCM
- **Input:** 220V~240V AC / 50Hz
- **Dimming:** ON-OFF/0-10V (Must conduct compatibility testing with the project site system in advance)
- **Net Weight:** Approx. 0.92Kg, excluding packaging

Order Model

Model	Comment	Power (W)	Driver	Beam	CCT	Reflector	Finish
OR150 R Recessed mounting 1 Series 50 Width	AL Adjustable Trimless	22 22W	E ON-OFF D 0-10V Dimming	1 16°	27 2700K	B Black	WT White
				3 36°	30 3000K	S Specular	
				4 46°	35 3500K	G Gold	
					40 4000K	H Haze	

Example: OR150AL-22E-140BWT

LIGNE PRO - MODEL:OR150AL-22

Linear Luminaires

WAC LIGHTING

Responsible Lighting®

Project Name:

Type:

Accessory

Model	Type	Dimension
OR150AL-RC008	8 Module Pre-Embedded Parts	

Light Curve Distribution @4000K Data

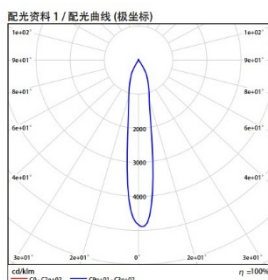

MODEL: OR150AL-22E-140BWT
BEAM ANGLE: 16°
POWER: 23.9W
LUMENS: 2418lm
CBCP: 11825
EFFICACY: 101lm/W

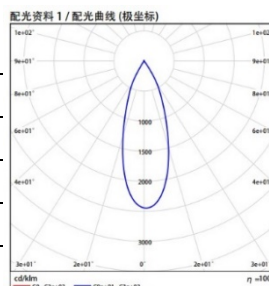

MODEL: OR150AL-22E-340BWT
BEAM ANGLE: 36°
POWER: 23.8W
LUMENS: 2395lm
CBCP: 6016
EFFICACY: 101lm/W

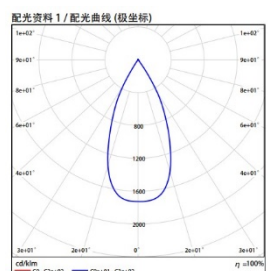

MODEL: OR150AL-22E-440BWT
BEAM ANGLE: 46°
POWER: 23.7W
LUMENS: 2414lm
CBCP: 4450
EFFICACY: 102lm/W

LIGNE PRO - MODEL:OR150AL-32

Linear Luminaires

WAC LIGHTING

Responsible Lighting®

Project Name:

Type:

Product Image



Line Drawing

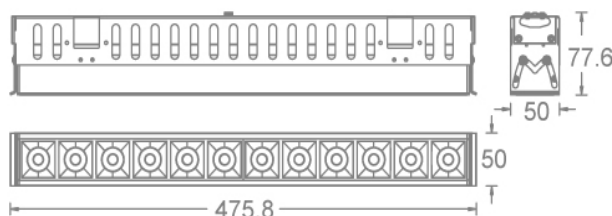

Product Description

LIGNE PRO is a recessed linear downlighting luminaire with an aluminum body. Aesthetic design with a simple and elegant exterior. It uses LED light source and the original SUBROSA anti-glare design. Various light distribution is available. It is mainly used in public space, commercial, office, display lighting and other places.

Product Features

- **Body Material:** Aluminum extruded lamp body
- **Optical System:** Lens + SUBROSA Invisible Light System
- **Finish:** Electrostatic Powder Coating
- **Adjustable Angle:** +/- 35° Adjustable
- **Accessories:** /
- **Certification:** CCC
- **IP Rating:** IP20
- **Insulation Level:** Class II
- **Operating Temperature:** -20°C~40°C

Product Specifications

- **Opening Size:** □490mm*63mm
- **Ceiling Thickness:** 5-25mm
- **Shading Angle:** 40°
- **LED Type:** High Power LED
- **Source Lm:** 2700K 3872lm; 3000K 4000lm; 3500K 4160lm; 4000K 4320lm
- **LED Lifetime:** >50000h-L70 /B10-Ta25°C(LM-80/TM-21)
- **CCT/CRI:** 2700K/3000K/3500K/4000K, Ra90
- **SDCM:** 3 SDCM
- **Input:** 220V~240V AC / 50Hz
- **Dimming:** ON-OFF/0-10V (Must conduct compatibility testing with the project site system in advance)
- **Net Weight:** Approx. 1.23Kg, excluding packaging

Order Model

Model	Comment	Power (W)	Driver	Beam	CCT	Reflector	Finish
OR150 R Recessed mounting 1 Series 50 Width	AL Adjustable Trimless	32 32W	E ON-OFF D 0-10V Dimming	1 16°	27 2700K	B Black	WT White
				3 36°	30 3000K	S Specular	
				4 46°	35 3500K	G Gold	
				40 4000K	H Haze		

Example: OR150AL-32E-140BWT

LIGNE PRO - MODEL:OR150AL-32

Linear Luminaires

WAC LIGHTING

Responsible Lighting®

Project Name:

Type:

Accessory

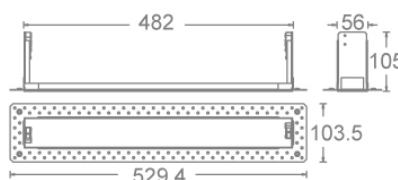
Model	Type	Dimension
OR150AL-RC012	12 Module Pre-Embedded Parts	

Light Curve Distribution @4000K Data

配光资料 1 / 配光曲线 (极坐标)

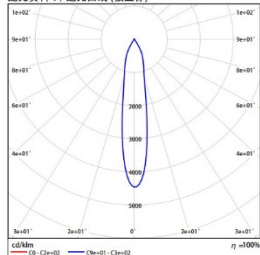

MODEL:	OR150AL-32E-140BWT
BEAM ANGLE:	16°
POWER:	35.6W
LUMENS:	3706lm
CBCP:	16833
EFFICACY:	104lm/W

配光资料 1 / 配光曲线 (极坐标)

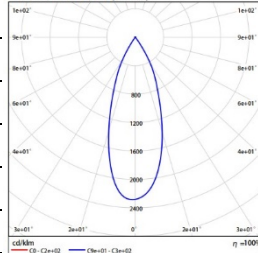

MODEL:	OR150AL-32E-340BWT
BEAM ANGLE:	36°
POWER:	35.5W
LUMENS:	3723lm
CBCP:	8520
EFFICACY:	105m/W

配光资料 1 / 配光曲线 (极坐标)

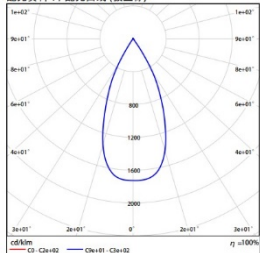

MODEL:	OR150AL-32E-440BWT
BEAM ANGLE:	46°
POWER:	35.7W
LUMENS:	3737lm
CBCP:	6452
EFFICACY:	105lm/W