

LANNE PRO - MODEL: ER22



Recessed Ceiling Luminaires

PROJECT :

TYPE :

Product Image



Line Drawing

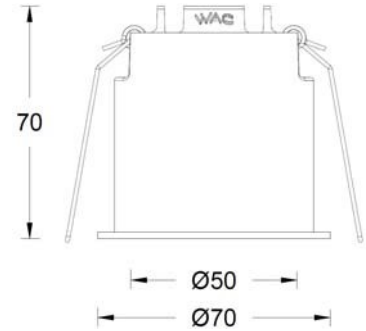

Product Description

The LANNE PRO lower lighting tube lamp is exquisite and simple, with precise light distribution. It adopts SUBROSA hidden light technology and has the ultimate anti glare effect. Mainly suitable for hotels and commercial public spaces.

Product Features

- Body Material: Aluminum alloy die-casting
- Optical System: Lens +Subrosa hidden light system
- Finish: Electrostatic powder coating,
- Adjustable Angle: /
- Accessories: /
- Certification: CCC
- IP Rating: IP65
- Insulation Level: Class I
- Operating Temperature: -20°C~50°C

Product Specifications

- Opening: Ø63mm
- Ceiling: 1mm~25mm
- Light: 35°
- Light source type: High Power LED
- Source Lm: 800lm
- LED Lifetime: >50000h-L70/B10-Ta25°C(LM-80/TM-21)
- CCT/CRI: 2700K/ 3000K/ 4000K , Ra90
- SDCM: 3 SDCM (4000K 5SDCM)
- Input: 220V~240V AC / 50Hz
- Dimming: No dimming/0-10V dimming
- Net Weight: 0.5Kg without packing

Order Model

Model	Size	Comment	LED Power	Driver	Beam	CCT	Reflector	Finish
ER2	2 2"	F Frame	08 8W	EL ON-OFF 220V AC Power Supply DL 0-10V Dimming 220V AC Power Supply	1 15°	27 2700K	B Black	WT White
					2 24°	30 3000K		
					3 36°	40 4000K	S Speculr	
					4 48°			

Example : ME22HLM28-E-2930WT

LANNE PRO - MODEL: ER22



Recessed Ceiling Luminaires

PROJECT :

TYPE :

LIGHT DISTRIBUTION@3000K LUMINAIRE DATA

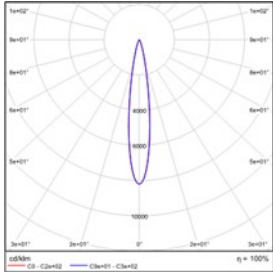

MODEL : ER22F-08EL-130BWT
BEAM ANGLE : 15°
POWER : 10W
LUMENS : 480LM
CBCP : 5810CD
EFFICACY : 48LM/W

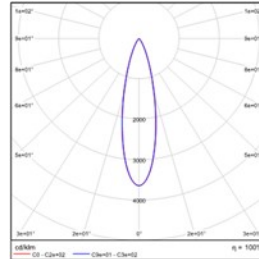

MODEL : ER22F-08EL-230BWT
BEAM ANGLE : 24°
POWER : 10W
LUMENS : 470LM
CBCP : 2342CD
EFFICACY : 47LM/W

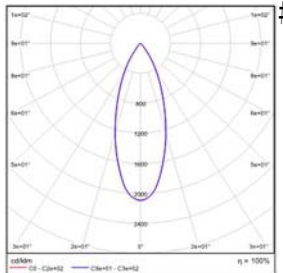

MODEL : ER22F-08EL-330BWT
BEAM ANGLE : 36°
POWER : 10W
LUMENS : 462LM
CBCP : 1594CD
EFFICACY : 46LM/W

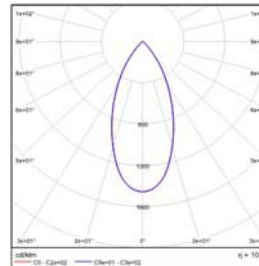

MODEL : ER22F-08EL-430BWT
BEAM ANGLE : 48°
POWER : 10W
LUMENS : 419LM
CBCP : 775CD
EFFICACY : 42LM/W

LANNE PRO - MODEL: ER23



Recessed Ceiling Luminaires

PROJECT :

TYPE :

Product Image



Line Drawing

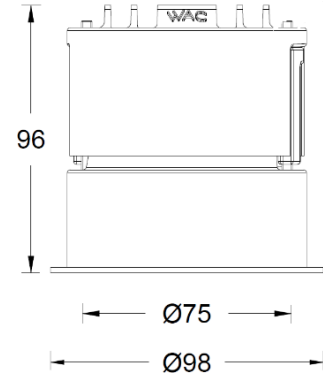

Product Description

The LANNE PRO lower lighting tube lamp is exquisite and simple, with precise light distribution. It adopts SUBROSA hidden light technology and has the ultimate anti glare effect. Mainly suitable for hotels and commercial public spaces.

Product Features

- Body Material: Aluminum alloy die-casting
- Optical System: Lens +Subrosa hidden light system
- Finish: Electrostatic powder coating,
- Adjustable Angle: /
- Accessories: /
- Certification: CCC
- IP Rating: IP65
- Insulation Level: Class I
- Operating Temperature: -20°C~50°C

Product Specifications

- Opening: Ø93mm
- Ceiling: 1mm~40mm
- Light: 35°
- Light source type: COB
- Source Lm: 1800lm
- LED Lifetime: >50000h-L70/B10-Ta25°C(LM-80/TM-21)
- CCT/CRI: 2700K/ 3000K/ 4000K , Ra90
- SDCM: 3 SDCM
- Input: 220V~240V AC / 50Hz
- Dimming: No dimming/0-10V dimming
- Net Weight: 1.5Kg without packing

Order Model

Model	Size	Comment	LED Power	Driver	Beam	CCT	Reflector	Finish
ER2	3 3"	F Frame	13 13W	EL ON-OFF 220V AC Power Supply	1 15°	27 2700K	B Black	WT White
					2 28°			
					3 38°			
					4 45°			
					5 58°			
ER2	3 3"	F Frame	18 18W	DL 0-10V Dimming 220V AC Power Supply	3 38°	30 3000K	S Specular	WT White
					4 45°			
					5 58°			
					30 3000K			
					40 4000K			

Example : ER23F-13EL-130BWT

Recessed Ceiling Luminaires

PROJECT :

TYPE :

LIGHT DISTRIBUTION@3000K LUMINAIRE DATA

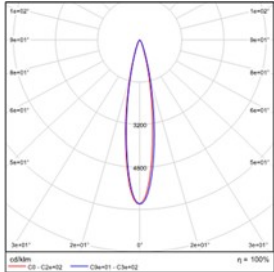

MODEL : ER23F-13EL-130BWT
BEAM ANGLE : 15°
POWER : 14W
LUMENS : 844LM
CBCP : 5213CD
EFFICACY : 60 LM/W

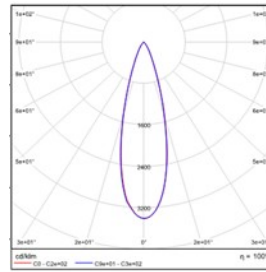

MODEL : ER23F-13EL-230BWT
BEAM ANGLE : 24°
POWER : 14W
LUMENS : 791LM
CBCP : 2860CD
EFFICACY : 56.6LM/W

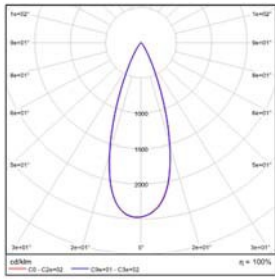

MODEL : ER23F-13EL-330BWT
BEAM ANGLE : 38°
POWER : 14W
LUMENS : 904LM
CBCP : 2477CD
EFFICACY : 65LM/W

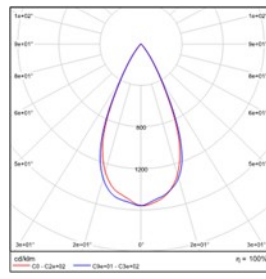

MODEL : ER22F-08EL-430BWT
BEAM ANGLE : 45°
POWER : 14W
LUMENS : 882LM
CBCP : 1504CD
EFFICACY : 62LM/W

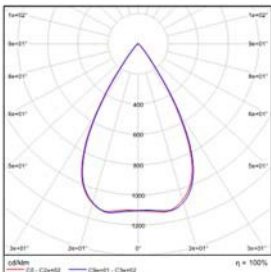

MODEL : ER23F-13EL-530BWT
BEAM ANGLE : 58°
POWER : 14W
LUMENS : 925LM
CBCP : 1111CD
EFFICACY : 67LM/W

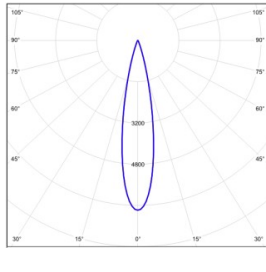

MODEL : ER23F-18EL-130BWT
BEAM ANGLE : 15°
POWER : 21W
LUMENS : 1047LM
CBCP : 6468CD
EFFICACY : 50LM/W

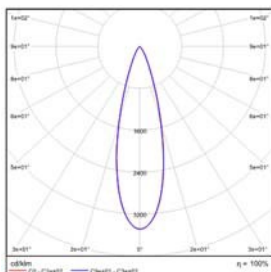

MODEL : ER23F-18EL-230BWT
BEAM ANGLE : 28°
POWER : 21W
LUMENS : 1084LM
CBCP : 3518CD
EFFICACY : 52LM/W

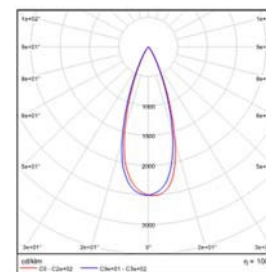

MODEL : ER23F-18EL-330BWT
BEAM ANGLE : 38°
POWER : 21W
LUMENS : 1241LM
CBCP : 3028CD
EFFICACY : 59LM/W

LANNE PRO - MODEL: ER23



Recessed Ceiling Luminaires

PROJECT :

TYPE :

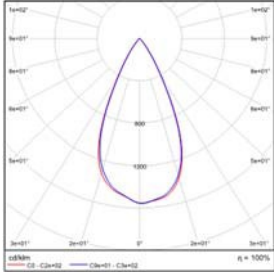

MODEL : ER23F-18EL-430BWT
BEAM ANGLE : 45°
POWER : 21W
LUMENS : 1096LM
CBCP : 1861CD
EFFICACY : 52LM/W

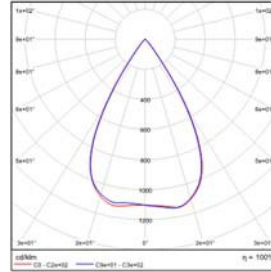

MODEL : ER23F-18EL-530BWT
BEAM ANGLE : 58°
POWER : 21W
LUMENS : 1204LM
CBCP : 1419CD
EFFICACY : 57LM/W

LANNE PRO - MODEL: ER24



Recessed Ceiling Luminaires

PROJECT :

TYPE :

Product Image



Line Drawing

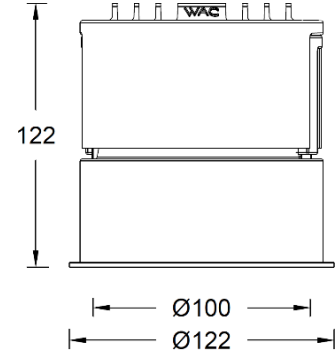

Product Description

The LANNE PRO lower lighting tube lamp is exquisite and simple, with precise light distribution. It adopts SUBROSA hidden light technology and has the ultimate anti glare effect. Mainly suitable for hotels and commercial public spaces.

Product Features

- Body Material: Aluminum alloy die-casting
- Optical System: Lens +Subrosa hidden light system
- Finish: Electrostatic powder coating,
- Adjustable Angle: /
- Accessories: /
- Certification: CCC
- IP Rating: IP65
- Insulation Level: Class I
- Operating Temperature: -20°C~50°C

Product Specifications

- Opening: Ø116mm
- Ceiling: 1mm~40mm
- Light: 35°
- Light source type: COB
- Source Lm: 2500lm
- LED Lifetime: >50000h-L70/B10-Ta25°C(LM-80/TM-21)
- CCT/CRI: 2700K/ 3000K/ 4000K , Ra90
- SDCM: 3 SDCM
- Input: 220V~240V AC / 50Hz
- Dimming: No dimming/0-10V dimming
- Net Weight: 1.5Kg without packing

Order Model

Model	Size	Comment	LED Power	Driver	Beam	CCT	Reflector	Finish		
ER2	4 4"	F Frame	18 18W	EL ON-OFF	1 20°	27 2700K	B Black	WT White		
				220V AC Power Supply	2 30°					
				DL 0-10V Dimming	3 40°				30 3000K	
				220V AC Power Supply	4 50°				40 4000K	S Specular
				5 60°						

Example : ER23F-13EL-130BWT

LANNE PRO - MODEL: ER24



Recessed Ceiling Luminaires

PROJECT :

TYPE :

LIGHT DISTRIBUTION@3000K LUMINAIRE DATA

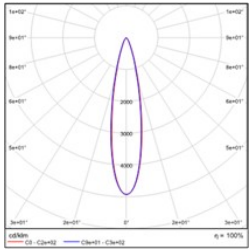

MODEL : ER24F-18EL-230BWT
BEAM ANGLE : 20°
POWER : 21W
LUMENS : 1445LM
CBCP : 7312CD
EFFICACY : 69 LM/W

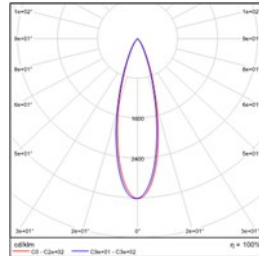

MODEL : ER24F-18EL-330BWT
BEAM ANGLE : 30°
POWER : 21W
LUMENS : 1332LM
CBCP : 4308CD
EFFICACY : 64LM/W

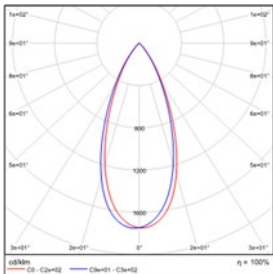

MODEL : ER24F-18EL-430BWT
BEAM ANGLE : 40°
POWER : 21W
LUMENS : 1371LM
CBCP : 2315CD
EFFICACY : 66LM/W

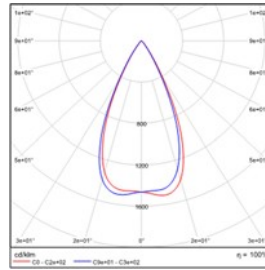

MODEL : ER24F-18EL-530BWT
BEAM ANGLE : 50°
POWER : 21W
LUMENS : 1660LM
CBCP : 2312CD
EFFICACY : 80LM/W

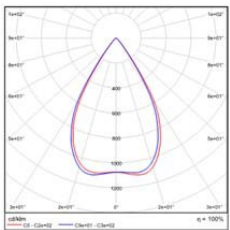

MODEL : ER24F-18EL-630BWT
BEAM ANGLE : 60°
POWER : 21W
LUMENS : 1584LM
CBCP : 1678CD
EFFICACY : 76LM/W

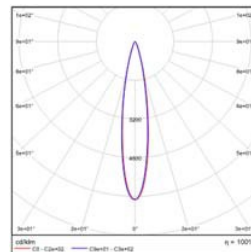

MODEL : ER24F-25EL-230BWT
BEAM ANGLE : 20°
POWER : 30W
LUMENS : 1446LM
CBCP : 10066CD
EFFICACY : 66LM/W

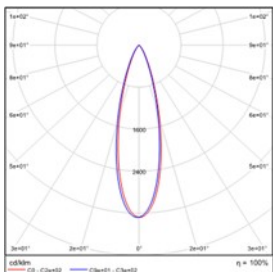

MODEL : ER24F-25EL-330BWT
BEAM ANGLE : 30°
POWER : 30W
LUMENS : 1771LM
CBCP : 5953CD
EFFICACY : 60LM/W

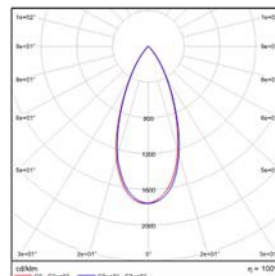

MODEL : ER24F-25EL-430BWT
BEAM ANGLE : 40°
POWER : 30W
LUMENS : 1817LM
CBCP : 3164CD
EFFICACY : 61.5LM/W

LANNE PRO - MODEL: ER24



Recessed Ceiling Luminaires

PROJECT :

TYPE :

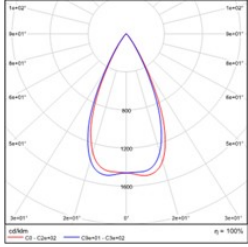

MODEL :	ER24F-25EL-530BWT
BEAM ANGLE :	50°
POWER :	30W
LUMENS :	2183LM
CBCP :	3281CD
EFFICACY :	74LM/W

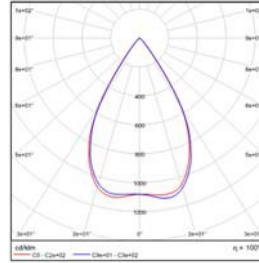

MODEL :	ER24F-25EL-630BWT
BEAM ANGLE :	60°
POWER :	30W
LUMENS :	2109LM
CBCP :	2337CD
EFFICACY :	71.2LM/W

LANNE PRO - MODEL: ER25



Recessed Ceiling Luminaires

PROJECT :

TYPE :

Product Image



Line Drawing

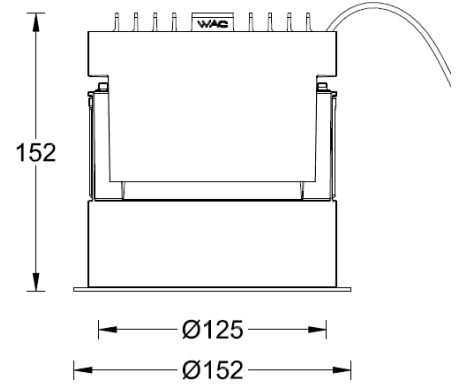

Product Description

The LANNE PRO lower lighting tube lamp is exquisite and simple, with precise light distribution. It adopts SUBROSA hidden light technology and has the ultimate anti glare effect. Mainly suitable for hotels and commercial public spaces.

Product Features

- Body Material: Aluminum alloy die-casting
- Optical System: Lens +Subrosa hidden light system
- Finish: Electrostatic powder coating,
- Adjustable Angle: /
- Accessories: /
- Certification: CCC
- IP Rating: IP65
- Insulation Level: Class I
- Operating Temperature: -20°C~50°C

Product Specifications

- Opening: Ø145mm
- Ceiling: 1mm~40mm
- Light: 35°
- Light source type: COB
- Source Lm: 4500lm
- LED Lifetime: >50000h-L70/B10-Ta25°C(LM-80/TM-21)
- CCT/CRI: 2700K/ 3000K/ 4000K , Ra90
- SDCM: 3 SDCM
- Input: 220V~240V AC / 50Hz
- Dimming: No dimming/0-10V dimming
- Net Weight: 2.3Kg without packing

Order Model

Model	Size	Comment	LED Power	Driver	Beam	CCT	Reflector	Finish
ER2	5 5"	F Frame	32 32W 40 40W	EL ON-OFF	1 15° 2 24° 3 36°	27 2700K	B Black S Specular	WT White
				220V AC Power Supply		30 3000K		
				DL 0-10V Dimming		40 4000K		
				220V AC Power Supply				

Example : ER23F-13EL-130BWT

LANNE PRO - MODEL: ER25



Recessed Ceiling Luminaires

PROJECT :

TYPE :

LIGHT DISTRIBUTION@3000K LUMINAIRE DATA

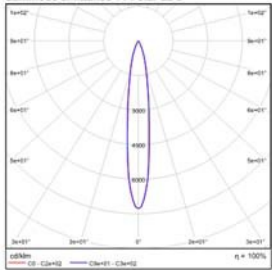

MODEL : ER25F-32EL-130BWT
BEAM ANGLE : 15°
POWER : 35W
LUMENS : 3031LM
CBCP : 21693CD
EFFICACY : 86 LM/W

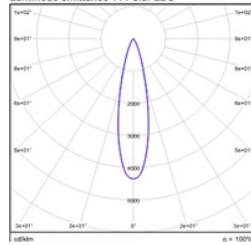

MODEL : ER25F-32EL-230BWT
BEAM ANGLE : 24°
POWER : 35W
LUMENS : 2870LM
CBCP : 12243CD
EFFICACY : 82LM/W

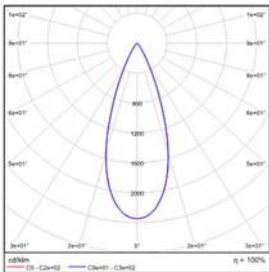

MODEL : ER25F-32EL-330BWT
BEAM ANGLE : 36°
POWER : 35W
LUMENS : 2905LM
CBCP : 6624CD
EFFICACY : 83LM/W

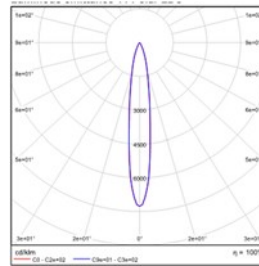

MODEL : ER25F-32EL-130BWT
BEAM ANGLE : 15°
POWER : 43W
LUMENS : 3683LM
CBCP : 2650CD
EFFICACY : 86LM/W

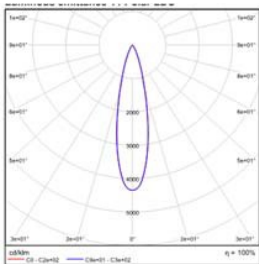

MODEL : ER25F-40EL-230BWT
BEAM ANGLE : 24°
POWER : 43W
LUMENS : 3537LM
CBCP : 15030CD
EFFICACY : 82.3LM/W

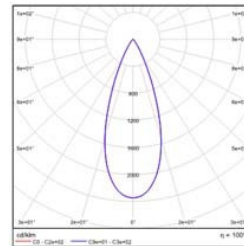

MODEL : ER25F-40EL-330BWT
BEAM ANGLE : 36°
POWER : 43W
LUMENS : 3605LM
CBCP : 8163CD
EFFICACY : 83.7LM/W