

VOLTA TUNABLE - MODEL: DDT41

4" Round Narrow Recessed Dimmable

WAC LIGHTING

Responsible Lighting®

Downlight

PROJECT:

TYPE:

Product Image



Line Drawing

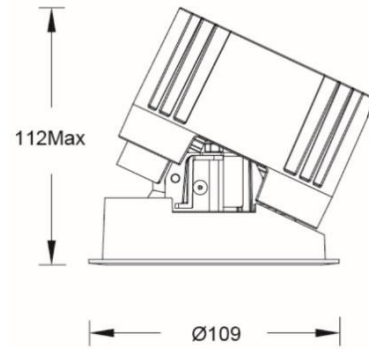

DESCRIPTION

The VOLTA Tunable series LED circular narrow edge embedded adjustable color temperature tube lamp has a streamlined appearance and adopts precise lens and black mirror reflector design, ensuring the ultimate anti glare effect while emitting light. The entire process of angle adjustment is free of impurities; The light source cavity adopts a sealed design, which can minimize the impact of humid environments on its performance; Reflectors or accessories can also be freely disassembled and replaced, greatly improving on-site convenience, mainly suitable for hotels and commercial indoor places.

Product Features

- Body Material: Aluminum alloy die-casting
- Optical System: Lens+Reflector
- Finish: Static electricity powder coating
- Adjustable Angle: /
- Accessories: See Attachment
- Certification: CCC
- IP Rating: IP20(Light source IP44)
- Insulation Level: Class II
- Operating Temperature: -20°C~40°C

Product Specifications

- Cut-out: Ø100mm
- Ceiling Thickness: 1mm~20mm
- Shielding Angle: 30°
- LED Type: COB
- Source Lm: 2000lm;
- LED Lifetime: >50000h-L70 /B10-Ta25°C(LM-80/TM-21)
- CCT/CRI: 2700K~6000Kadjustable, Ra90
- Input: 220V AC/ 50Hz
- Dimming: DALI (must undergo compatibility testing with the project site system in advance)
- Net Weight: 0.6Kg , without packing

Ordering model

Model	Size	Trim	LED	Driver	Beam	CCT	Reflector	Finish
DDT	4	1	LM18	A DALI	1 18°	CC	B Black	WT White
Downlight	4"	Round Trim	COB 18W	N No Driver	2 28°	2700K~6000K	S Specular	BK Black
Directional					3 38°	(Tunable)		
T series					5 50°			

Example: DDT41-LM18A-2CCSWT

VOLTA TUNABLE - MODEL: DDT41

4" Round Narrow Recessed Dimmable Downlight



WAC LIGHTING

Responsible Lighting®

PROJECT:

TYPE:

Accessory

LENS-DDT41-BEL Striped glass lenses		LENS-DDT41-HCL Borderless honeycomb grille	
---	---	--	---

Attention: At most one optical accessory can be added, and it is not included in the factory. It needs to be ordered separately

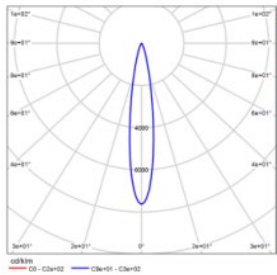

MODEL: DDT41-LM18A-1CCSWT
BEAM ANGLE: 18°
POWER: 21W
LUMENS: 1349lm
CBCP: 9081cd
EFFICACY: 64lm/W

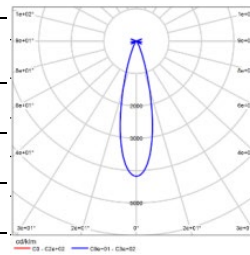

MODEL: DDT41-LM18A-2CCSWT
BEAM ANGLE: 28°
POWER: 21W
LUMENS: 6025lm
CBCP: 6025cd
EFFICACY: 66lm/W

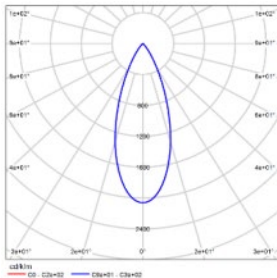

MODEL: DDT41-LM18A-3CCSWT
BEAM ANGLE: 38°
POWER: 21W
LUMENS: 1421lm
CBCP: 2871cd
EFFICACY: 68lm/W

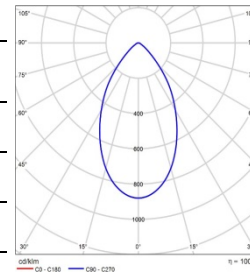

MODEL: DDT41-LM18A-5CCSWT
BEAM ANGLE: 50°
POWER: 21W
LUMENS: 1184lm
CBCP: 1558cd
EFFICACY: 56lm/W

VOLTA TUNABLE - MODEL: DDT51

5" Round Narrow Recessed Dimmable Downlight

WAC LIGHTING
Responsible Lighting®

PROJECT:

TYPE:

Product Image



Line Drawing

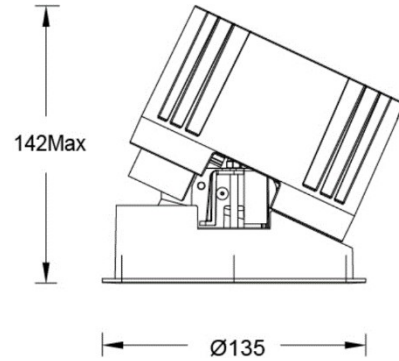

DESCRIPTION

The VOLTA Tunable series LED circular narrow edge embedded adjustable color temperature tube lamp has a streamlined appearance and adopts precise lens and black mirror reflector design, ensuring the ultimate anti glare effect while emitting light. The entire process of angle adjustment is free of impurities; The light source cavity adopts a sealed design, which can minimize the impact of humid environments on its performance; Reflectors or accessories can also be freely disassembled and replaced, greatly improving on-site convenience, mainly suitable for hotels and commercial indoor places.

Product Features

- Body Material: Aluminum alloy die-casting
- Optical System: Lens+ honeycomb
- Finish: Static electricity powder coating
- Adjustable Angle: Vertical 0-25 ° adjustment
- Accessories: See Attachment
- Certification: CCC
- IP Rating: IP20(Light source cavity IP44)
- Insulation Level: Class II
- Operating Temperature: -20°C~40°C

Product Specifications

- Cut-out: Ø125mm
- Ceiling Thickness: 1mm~25mm
- Shielding Angle: 30°
- LED Type: COB
- Source Lm: 2500lm;
- LED Lifetime: >50000h-L70 /B10-Ta25°C(LM-80/TM-21)
- CCT/CRI: 2700K~6000K adjustable,Ra90
- Input: 220V AC /50Hz
- Dimming: DALI (must undergo compatibility testing with the project site system in advance)
- Net Weight: 1.1Kg , without packing

Ordering model

Model	Size	Trim	LED	Driver	Beam	CCT	Reflector	Finish
DDT Downlight	5 5"	1 Round Trim	LM25 COB 25W	A DALI N No Driver	1 18° 2 28° 3 38° 5 50°	CC 2700K~6000K (Tunable)	B Black S Specular	WT White BK Black
Directional T series								

Example: DDT51-LM25A-2CCSWT

VOLTA TUNABLE - MODEL: DDT51



5" Round Narrow Recessed Dimmable Downlight

WAC LIGHTING
Responsible Lighting®

PROJECT:

TYPE:

Accessory

LENS-DDT51-BEL Striped glass lenses 	LENS-DDT51-HCL Borderless honeycomb grille 
---	--

Attention: At most one optical accessory can be added, and it is not included in the factory. It needs to be ordered separately

LIGHT DISTRIBUTION@3000K LUMINAIRE DATA

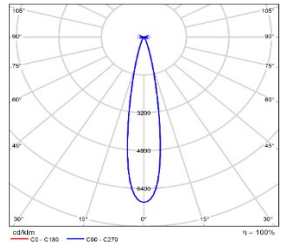
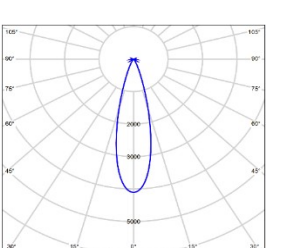
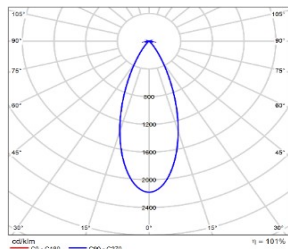
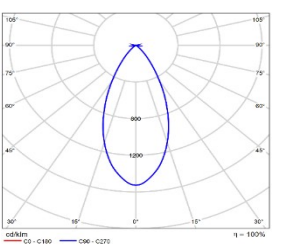
	MODEL: DDT51-LM25A-1CCSWT BEAM ANGLE: 18° POWER: 28W LUMENS: 2094lm CBCP: 14632cd EFFICACY: 75lm/W		MODEL: DDT51-LM25A-2CCSWT BEAM ANGLE: 28° POWER: 28W LUMENS: 1957lm CBCP: 8073cd EFFICACY: 70lm/W
	MODEL: DDT51-LM25A-3CCSWT BEAM ANGLE: 38° POWER: 28W LUMENS: 2142lm CBCP: 4668cd EFFICACY: 77lm/W		MODEL: DDT51-LM25A-5CCSWT BEAM ANGLE: 50° POWER: 28W LUMENS: 1830lm CBCP: 2794cd EFFICACY: 65lm/W

VOLTA TUNABLE - MODEL: DDT61

6" Round Narrow Recessed Dimmable Downlight

WAC LIGHTING
Responsible Lighting®

PROJECT:

TYPE:

Product Image



Line Drawing

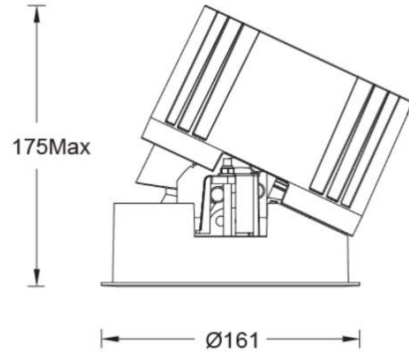

DESCRIPTION

The VOLTA Tunable series LED circular narrow edge embedded adjustable color temperature tube lamp has a streamlined appearance and adopts precise lens and black mirror reflector design, ensuring the ultimate anti glare effect while emitting light. The entire process of angle adjustment is free of impurities; The light source cavity adopts a sealed design, which can minimize the impact of humid environments on its performance; Reflectors or accessories can also be freely disassembled and replaced, greatly improving on-site convenience, mainly suitable for hotels and commercial indoor places.

Product Features

- Body Material: Aluminum alloy die-casting
- Optical System: Lens+ honeycomb
- Finish: Static electricity powder coating
- Adjustable Angle: Vertical 0-25 ° adjustment
- Accessories: See Attachment
- Certification: CCC
- IP Rating: IP20(Light source cavity IP44)
- Insulation Level: Class II
- Operating Temperature: -20°C~40°C

Product Specifications

- Cut-out: Ø150mm
- Ceiling Thickness: 1mm~30mm
- Shielding Angle: 30°
- LED Type: COB
- Source Lm: 4500lm;
- LED Lifetime: >50000h-L70 /B10-Ta25°C(LM-80/TM-21)
- CCT/CRI: 2700K~6000K adjustable,Ra90
- Input: 220V AC /50Hz
- Dimming: DALI (must undergo compatibility testing with the project site system in advance)
- Net Weight: 1.7Kg , without packing

Ordering model

Model	Size	Trim	LED	Driver	Beam	CCT	Reflector	Finish
DDT Downlight Directional T series	6 6"	1 Round Trim	LM43 COB 43W	A DALI N No Driver	1 18°	CC 2700K~6000K (Tunable)	B Black S Specular	WT White BK Black
					2 28°			
					3 38°			
					5 50°			

Example: DDT61-LM43A-2CCSWT

VOLTA TUNABLE - MODEL: DDT61



6" Round Narrow Recessed Dimmable Downlight

WAC LIGHTING
Responsible Lighting®

PROJECT:

TYPE:

Accessory

LENS-DDT61-BEL Striped glass lenses		LENS-DDT61-HCL Borderless honeycomb grille	
---	---	--	---

Attention: At most one optical accessory can be added, and it is not included in the factory. It needs to be ordered separately

LIGHT DISTRIBUTION@3000K LUMINAIRE DATA

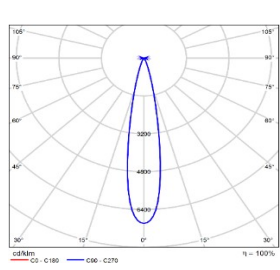

MODEL:	DDT61-LM43A-1CCSWT
BEAM ANGLE:	18°
POWER:	47W
LUMENS:	3254lm
CBCP:	20859cd
EFFICACY:	65lm/W

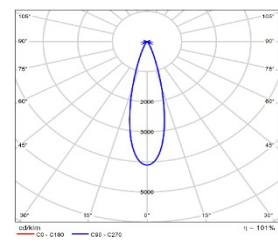

MODEL:	DDT61-LM43A-2CCSWT
BEAM ANGLE:	28°
POWER:	47W
LUMENS:	3271lm
CBCP:	14257cd
EFFICACY:	70lm/W

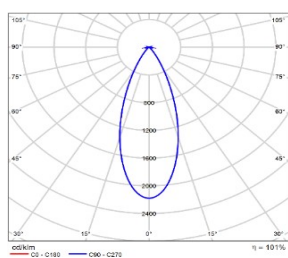

MODEL:	DDT61-LM43A-3CCSWT
BEAM ANGLE:	38°
POWER:	47W
LUMENS:	3367lm
CBCP:	7111cd
EFFICACY:	72lm/W

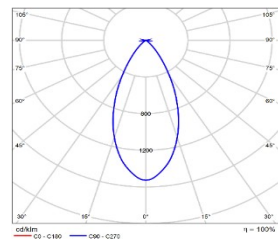

MODEL:	DDT61-LM43A-5CCSWT
BEAM ANGLE:	50°
POWER:	47W
LUMENS:	3249lm
CBCP:	4052cd
EFFICACY:	69lm/W