

ELANA- MODEL: DLG21

2" Narrow Trim Recessed Downlight

PROJECT :



TYPE :

Product Image



Line Drawing

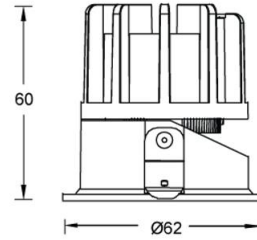

Product Description

The ELANA series LED narrow edge embedded downlight integrates perfectly with the ceiling after installation. Good anti-glare performance and color consistency control, with comfortable light output effect, mainly suitable for indoor places such as hotels and clubs.-

Product Features

- Body Material: Aluminum alloy die-casting
- Optical System: Lens+ Anti-glare reflector
Reflector surface treatment:
B Black
W White
S Black Mirror
T Black staircase
H White staircase
- Finish: Static electricity powder
- Adjustable Angle: /
- Accessories: As attached
- Certification: CCC/CE
- IP Rating: IP20
- Insulation Level: Class II
- Operating Temperature: -20°C~40°C

Product Specifications

- Cut-out: Ø 55mm
- Ceiling Thickness: 5mm~25mm
- Shielding Angle: 35°
- LED Type: COB
- Source Lm:
2700K: 4W 540lm ; 7W 758lm;
3000K: 4W 557lm ; 7W 780lm;
3500K: 4W 578lm ; 7W 810lm;
4000K: 4W 589lm ; 7W 825lm;
5000K: 4W 594lm ; 7W 832lm;
- LED Lifetime: >36000h-L70 /B10-Ta25°C(LM-80/TM-21)
- CCT/CRI: 2700K/3000K/3500K/4000K/5000K , CRI≥90
- Input: 220V~240V AC / 50Hz
- Dimming: No diming/ 0-10V (Must conduct compatibility testing with the project site system in advance)
- Net Weight: 0.11Kg without packing

Order Model

Model	Size	Trim	LED	Driver	Beam	CCT	Reflector	Finish
DLG Downlight G series	2	1 Round Trim	LM04 COB 4W	E On-Off	1 15°	27 2700K	B Black	WT
			LM07 COB 7W	D 0-10V Dimming	2 24°	30 3000K	W White	White
			LM07 COB 7W	N No Driver	3 36°	35 3500K	S Specular	BK
					5 50°	40 4000K 50 5000K	T Black Step H White Step	Black

Example : DLG21-LM07-E130SWT

Note: The 15 °and 24° factory default comes with an borderless honeycomb grille.

ELANA- MODEL: DLG21

2" Narrow Trim Recessed Downlight

PROJECT :



TYPE :

LENS-11-HCL-ELANA

Honeycomb



LIGHT DISTRIBUTION@3000K LUMINAIRE DATA

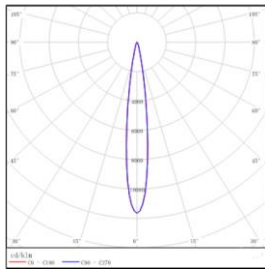

MODEL : DLG21-LM04-E130BWT
BEAM ANGLE : 15°
POWER : 5.4W
LUMENS : 215lm
CBCP : 2014cd
EFFICACY : 39lm/W

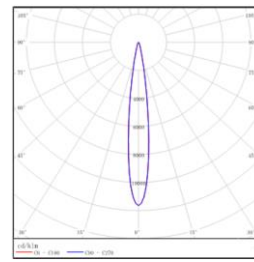

MODEL : DLG21-LM07-E130BWT
BEAM ANGLE : 15°
POWER : 8W
LUMENS : 306lm
CBCP : 2867cd
EFFICACY : 38lm/W

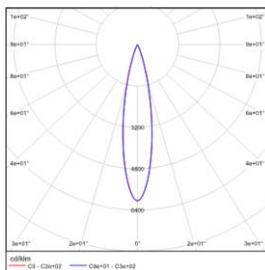

MODEL : DLG21-LM04-E230BWT
BEAM ANGLE : 24°
POWER : 5.4W
LUMENS : 249lm
CBCP : 1532cd
EFFICACY : 45lm/W

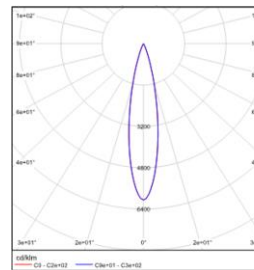

MODEL : DLG21-LM07-E230BWT
BEAM ANGLE : 24°
POWER : 8W
LUMENS : 355lm
CBCP : 2181cd
EFFICACY : 44lm/W

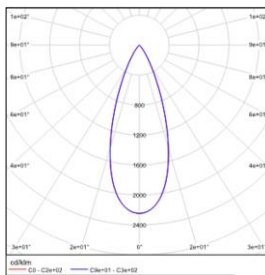

MODEL : DLG21-LM04-E330BWT
BEAM ANGLE : 36°
POWER : 5.4W
LUMENS : 314lm
CBCP : 778cd
EFFICACY : 57lm/W

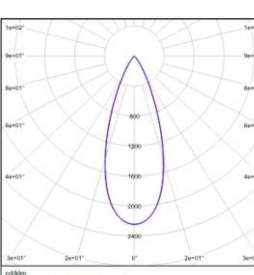

MODEL : DLG21-LM07-E330BWT
BEAM ANGLE : 36°
POWER : 8W
LUMENS : 447lm
CBCP : 1104cd
EFFICACY : 55lm/W

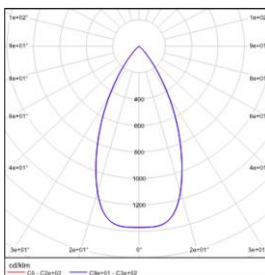

MODEL : DLG21-LM04-E530BWT
BEAM ANGLE : 50°
POWER : 5.4W
LUMENS : 342lm
CBCP : 509cd
EFFICACY : 62lm/W

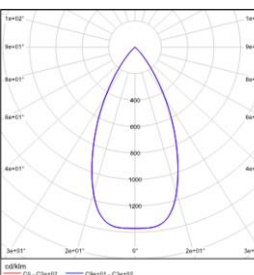

MODEL : DLG21-LM07-E530BWT
BEAM ANGLE : 50°
POWER : 8W
LUMENS : 486lm
CBCP : 725cd
EFFICACY : 60lm/W

ELANA - MODEL: DLG31

3" Narrow Trim Recessed Downlight

PROJECT :



TYPE :

Product Image



Line Drawing

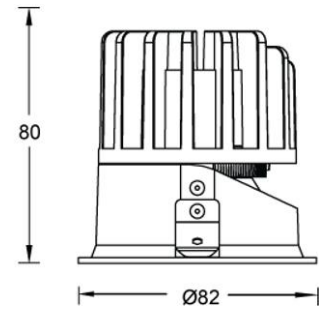

Product Description

The ELANA series LED narrow edge embedded downlight integrates perfectly with the ceiling after installation. Good anti-glare performance and color consistency control, with comfortable light output effect, mainly suitable for indoor places such as hotels and clubs.-

Product Features

- Body Material: Aluminum alloy die-casting
- Optical System: Lens+ Anti-glare reflector
Reflector surface treatment:
B Black
W White
S Black Mirror
T Black staircase
H White staircase
- Finish: Static electricity powder
- Adjustable Angle: /
- Accessories: As attached
- Certification: CCC/CE
- IP Rating: IP20
- Insulation Level: Class II
- Operating Temperature: -20°C~40°C

Product Specifications

- Cut-out: Ø 75mm
- Ceiling Thickness: 5mm~25mm
- Shielding Angle: 35°
- LED Type: COB
- Source Lm:
2700K: 7W 758lm; 10W 1080lm; 13W 1404lm
3000K: 7W 800lm; 10W 1150lm; 13W 1495lm
3500K: 7W 835lm; 10W 1195lm; 13W 1554lm
4000K: 7W 850lm; 10W 1210lm; 13W 1573lm
5000K: 7W 860lm; 10W 1220lm; 13W 1586lm
- LED Lifetime: >36000h-L70 /B10-Ta25°C(LM-80/TM-21)
- CCT/CRI: 2700K/3000K/3500K/4000K/5000K , CRI≥90
- Input: 220V~240V AC / 50Hz
- Dimming: No diming/ 0-10V (Must conduct compatibility testing with the project site system in advance)
- Net Weight: 0.24Kg without packing

Order Model

Model	Size	Trim	LED	Driver	Beam	CCT	Reflector	Finish
DLG Downlight G series	3	1 Round Trim	LM07 COB7W	E On-Off	1 15°	27 2700K	B Black	WT
			LM10 COB 10W	D 0-10V	2 24°	30 3000K	W White	White
			LM13 COB 13W	Dimming	3 36°	35 3500K	S Specular	BK
			LM13 COB 13W	N No Driver	5 50°	40 4000K 50 5000K	T Black Step H White Step	Black

Example : DLG21-LM07-E130SWT

Note: The 15 °and 24° factory default comes with an borderless honeycomb grille.

ELANA - MODEL: DLG31

3" Narrow Trim Recessed Downlight

PROJECT :

WAC

TYPE :

LENS-11-HCL-ELANA

Honeycomb



LIGHT DISTRIBUTION@3000K LUMINAIRE DATA

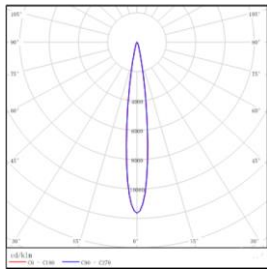

MODEL : DLG31-LM07-E130BWT

BEAM ANGLE : 15°

POWER : 8W

LUMENS : 340lm

CBCP : 3781cd

EFFICACY : 42lm/W

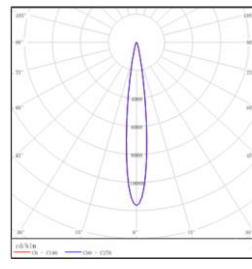

MODEL : DLG31-LM10-E130BWT

BEAM ANGLE : 15°

POWER : 11W

LUMENS : 456lm

CBCP : 5076cd

EFFICACY : 41lm/W

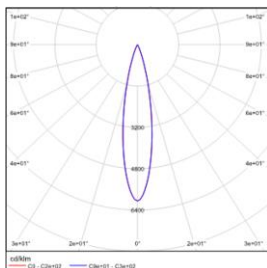

MODEL : DLG31-LM13-E130BWT

BEAM ANGLE : 24°

POWER : 15W

LUMENS : 615lm

CBCP : 6839cd

EFFICACY : 41lm/W

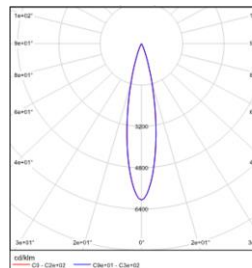

MODEL : DLG31-LM07-E230BWT

BEAM ANGLE : 24°

POWER : 8W

LUMENS : 416lm

CBCP : 2223cd

EFFICACY : 52lm/W

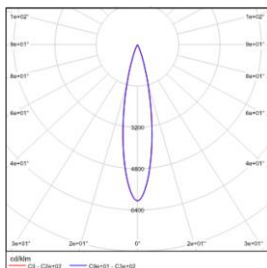

MODEL : DLG31-LM10-E230BWT

BEAM ANGLE : 24°

POWER : 11W

LUMENS : 558lm

CBCP : 2985cd

EFFICACY : 50lm/W

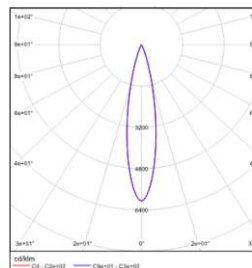

MODEL : DLG31-LM13-E230BWT

BEAM ANGLE : 24°

POWER : 15W

LUMENS : 753lm

CBCP : 4021cd

EFFICACY : 50lm/W

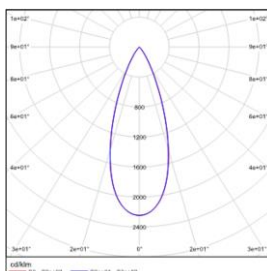

MODEL : DLG31-LM07-E330BWT

BEAM ANGLE : 36°

POWER : 8W

LUMENS : 604lm

CBCP : 1272cd

EFFICACY : 75lm/W

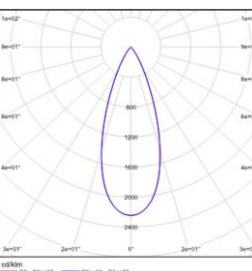

MODEL : DLG31-LM10-E330BWT

BEAM ANGLE : 36°

POWER : 11W

LUMENS : 809lm

CBCP : 1703cd

EFFICACY : 73lm/W

ELANA - MODEL: DLG31

3" Narrow Trim Recessed Downlight

PROJECT :



TYPE :

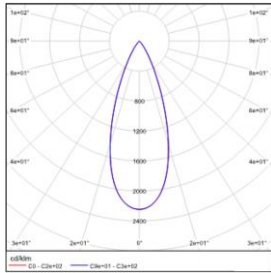

MODEL :	DLG31-LM13-E330BWT
BEAM ANGLE :	36°
POWER :	15W
LUMENS :	1090lm
CBCP :	2285cd
EFFICACY :	72lm/W

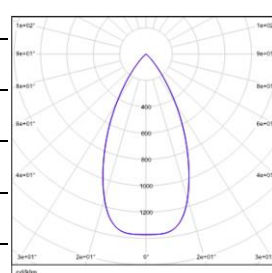

MODEL :	DLG31-LM07-E530BWT
BEAM ANGLE :	50°
POWER :	8W
LUMENS :	573lm
CBCP :	773cd
EFFICACY :	71lm/W

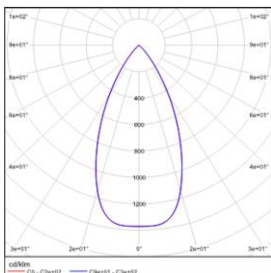

MODEL :	DLG31-LM10-E530BWT
BEAM ANGLE :	50°
POWER :	11W
LUMENS :	770lm
CBCP :	1038cd
EFFICACY :	70lm /W

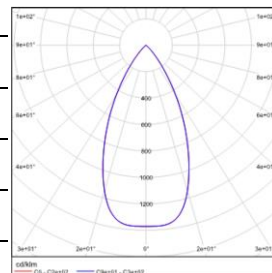

MODEL :	DLG31-LM13-E530BWT
BEAM ANGLE :	50°
POWER :	15W
LUMENS :	1038lm
CBCP :	1398cd
EFFICACY :	69lm /W