

# VOLTA- MODEL: DLT45

4 "square narrow edge recessed downlight

# WAC LIGHTING

Responsible Lighting®

PROJECT:

TYPE:

Product Image

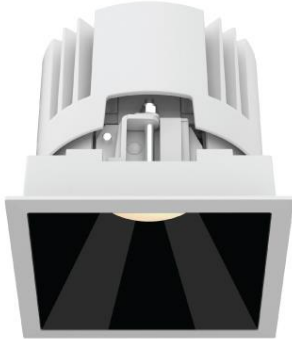

Line Drawing

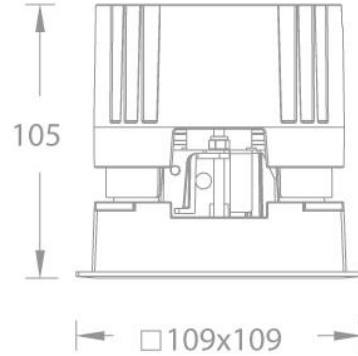

### Product Description

VOLTA series LED square narrow side embedded downlight, streamlined appearance, using accurate lens and black mirror reflector design, to ensure light while still achieve the ultimate anti-glare effect, the light source cavity is sealed design, can minimize the impact of wet environment on its performance; It can also be freely disassembled and replaced with reflectors or optical accessories, greatly improving the convenience of the site, mainly for hotels and commercial indoor places.

### Product Features

- **Body Material:** Aluminum alloy die-cast lamp body
- **Optical System:** Lens + reflector
- **Finish:** electrostatic powder spraying
- **Projection Direction:** /
- **Accessories:** see the attachment
- **Certification:** CCC
- **IP Rating:** IP20(Light source cavity IP44)
- **Insulation Level:** Class II
- **Operating Temperature:** -20°C~40°C

### Product Specification

- **Cut Out:** □100x100mm
- **Ceiling thickness:** 1mm~20mm
- **lamp shielding angle:** 30°
- **LED Type:** COB
- **Source Lm:** 2700K: 8W 685lm; 13W 1380lm; 18W 1860lm  
3000K: 8W 720lm; 13W 1465lm; 18W 1975lm  
3500K: 8W 750lm; 13W 1540lm; 18W 2070lm  
4000K: 8W 765lm; 13W 1600lm; 18W 2155lm  
5000K: 8W 775lm; 13W 1645lm; 18W 2220lm
- **LED Lifetime:** >50000h-L70 /B10-Ta25°C(LM-80/TM-21)
- **CCT/CRI:** 2700K/3000K/3500K/4000K/5000K, CRI≥90
- **Input:** 220V AC / 50Hz
- **Dimming:** Non-dimming /0-10V/DALI(must be tested with the project site system in advance)
- **Net Weight:** Approx. 0.7Kg without packing

### Order Model

Model	Size	Trim	LED	Driver	Beam	CCT	Reflector	Finish
DLT Downlight T series	4 4"	5 Square Trim	LD08 LED 8W	E On-Off D 0-10V Dimming	S 8°	27 2700K	B Black	WT White
			LM13 COB 13W		1 15°	30 3000K	S Specular	BK Black
			LM18 COB 18W	2 24°	35 3500K			
			LM18 COB 18W	3 36°	40 4000K			
			LM18 COB 18W	N No Driver A DALI	5 50°	50 5000K		

Example: DLT45-LM18E-230SWT

WAC Lighting  
www.waclighting.com (US)  
www.waclighting.com.cn (China)

Headquarters  
44 Harbor Park Drive • Port Washington, NY  
Phone (516) 515.5000 • Fax (516) 515.5050

WAC Lighting Technology (Shanghai) Co, Ltd.  
14,Lane 299, Bi Sheng Road,Shanghai 201204  
Phone (86.21) 3393.3558 • Fax (86.21) 3362.1598

# VOLTA- MODEL: DLT45

4 "square narrow edge recessed downlight



# WAC LIGHTING

Responsible Lighting®

PROJECT:

TYPE:

## Accessories

<b>LENS-DLT41-BEL</b> Striped glass lens		<b>LENS-DLT41-HCL</b> The endless bee net grid	
---	---	---	---

Note: Up to one optical accessory can be added, the factory is not equipped with accessories, need to order separately

## LIGHT DISTRIBUTION @3000K DATA

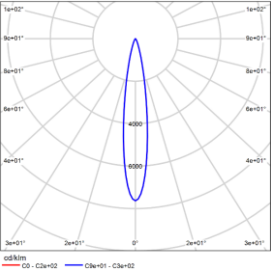
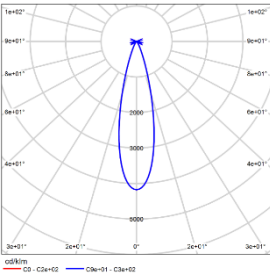
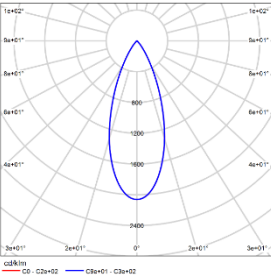
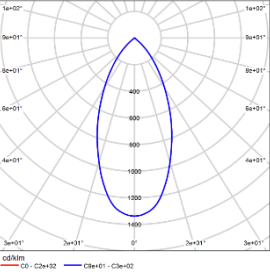
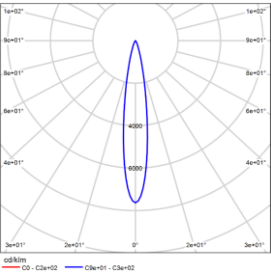
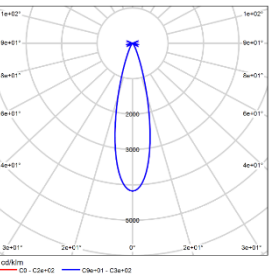
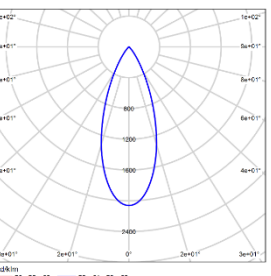
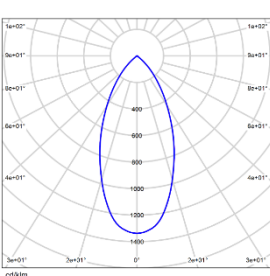
	<p><b>MODEL:</b> DLT45-LM13E-130SWT</p> <p><b>BEAM ANGLE:</b> 15°</p> <p><b>POWER:</b> 15W</p> <p><b>LUMENS:</b> 884lm</p> <p><b>CBCP:</b> 6749cd</p> <p><b>EFFICACY:</b> 59lm/W</p>		<p><b>MODEL:</b> DLT45-LM13E-230SWT</p> <p><b>BEAM ANGLE:</b> 24°</p> <p><b>POWER:</b> 15W</p> <p><b>LUMENS:</b> 1128lm</p> <p><b>CBCP:</b> 4708cd</p> <p><b>EFFICACY:</b> 75lm/W</p>
	<p><b>MODEL:</b> DLT45-LM13E-330SWT</p> <p><b>BEAM ANGLE:</b> 36°</p> <p><b>POWER:</b> 15W</p> <p><b>LUMENS:</b> 1204lm</p> <p><b>LUMENS:</b> 2482cd</p> <p><b>CBCP:</b> 80lm/W</p> <p><b>EFFICACY:</b></p>		<p><b>MODEL:</b> DLT45-LM13E-530SWT</p> <p><b>BEAM ANGLE:</b> 50°</p> <p><b>POWER:</b> 15W</p> <p><b>POWER:</b> 995lm</p> <p><b>LUMENS:</b> 1330cd</p> <p><b>CBCP:</b> 66lm/W</p> <p><b>EFFICACY:</b></p>
	<p><b>MODEL:</b> DLT45-LM18E-130SWT</p> <p><b>BEAM ANGLE:</b> 15°</p> <p><b>POWER:</b> 22W</p> <p><b>LUMENS:</b> 1258lm</p> <p><b>CBCP:</b> 9597cd</p> <p><b>EFFICACY:</b> 57lm/W</p>		<p><b>MODEL:</b> DLT45-LM18E-230SWT</p> <p><b>BEAM ANGLE:</b> 24°</p> <p><b>POWER:</b> 21W</p> <p><b>LUMENS:</b> 1604lm</p> <p><b>CBCP:</b> 6695cd</p> <p><b>EFFICACY:</b> 76lm/W</p>
	<p><b>MODEL:</b> DLT45-LM18E-330SWT</p> <p><b>BEAM ANGLE:</b> 36°</p> <p><b>POWER:</b> 21W</p> <p><b>LUMENS:</b> 1712lm</p> <p><b>CBCP:</b> 3529cd</p> <p><b>EFFICACY:</b> 82lm/W</p>		<p><b>MODEL:</b> DLT45-LM18E-530SWT</p> <p><b>BEAM ANGLE:</b> 50°</p> <p><b>POWER:</b> 21W</p> <p><b>LUMENS:</b> 1414lm</p> <p><b>CBCP:</b> 1891cd</p> <p><b>EFFICACY:</b> 67lm/W</p>

WAC Lighting  
[www.waclighting.com](http://www.waclighting.com) (US)  
[www.waclighting.com.cn](http://www.waclighting.com.cn) (China)

Headquarters  
 44 Harbor Park Drive • Port Washington, NY  
 Phone (516) 515.5000 • Fax (516) 515.5050

WAC Lighting Technology (Shanghai) Co, Ltd.  
 14,Lane 299, Bi Sheng Road,Shanghai 201204  
 Phone (86.21) 3393.3558 • Fax (86.21) 3362.1598

# VOLTA- MODEL: DLT45

4 "square narrow edge recessed downlight

# WAC LIGHTING

Responsible Lighting®

PROJECT:

TYPE:

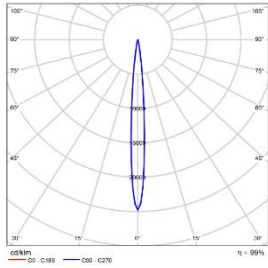

**MODEL:** DLT45-LD08E-S30SWT  
**BEAM ANGLE:** 8°  
**POWER:** 11W  
**LUMENS:** 375lm  
**CBCP:** 9280cd  
**EFFICACY:** 34lm/W

# VOLTA- MODEL: DLT55

# WAC LIGHTING

Responsible Lighting®

5 "square narrow edge recessed downlight

PROJECT:

TYPE:

Product Image



Line Drawing

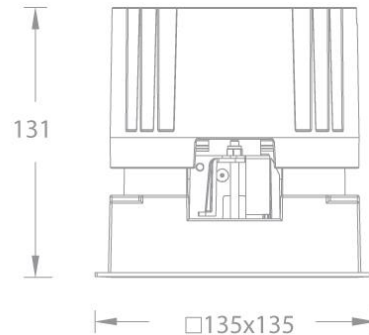

## Product Description

VOLTA series LED square narrow side embedded downlight, streamlined appearance, using accurate lens and black mirror reflector design, to ensure light while still achieve the ultimate anti-glare effect, the light source cavity is sealed design, can minimize the impact of wet environment on its performance; It can also be freely disassembled and replaced with reflectors or optical accessories, greatly improving the convenience of the site, mainly for hotels and commercial indoor places.

## Product Features

- **Body Material:** Aluminum alloy die-cast lamp body
- **Optical System:** Lens + reflector
- **Finish:** electrostatic powder spraying
- **Projection Direction:** /
- **Accessories:** see the attachment
- **Certification:** CCC
- **IP Rating:** IP20(Light source cavity IP44)
- **Insulation Level:** Class II
- **Operating Temperature:** -20°C~40°C

## Product Specification

- **Cut Out:** □125x125mm
- **Ceiling thickness:** 1mm~25mm
- **lamp shielding angle:** 30°
- **LED Type:** COB (where 8° is HP LED)
- **Source Lm:**
  - 2700K: 24W 2055lm; 18W 1860lm; 25W 2460lm; 32W 3065lm
  - 3000K: 24W 2160lm; 18W 1975lm; 25W 2610lm; 32W 3255lm
  - 3500K: 24W 2250lm; 18W 2070lm; 25W 2710lm; 32W 3380lm
  - 4000K: 24W 2295lm; 18W 2155lm; 25W 2790lm; 32W 3480lm
  - 5000K: 24W 2325lm; 18W 2220lm; 25W 2870lm; 32W 3580lm
- **LED Lifetime:** >50000h-L70 /B10-Ta25°C(LM-80/TM-21)
- **CCT/CRI:** 2700K/3000K/3500K/4000K/5000K, CRI≥90
- **Input:** 220V AC / 50Hz
- **Dimming:** Non-dimming /0-10V/DALI(must be tested with the project site system in advance)
- **Net Weight:** Approx. 1.1Kg, without packaging

## Order Model

Model	Size	Trim	LED	Driver	Beam	CCT	Reflector	Finish
DLT Downlight T series	5 5"	5 Square Trim	LD24 LED 24W	E On-Off D 0-10V Dimming	S 8°	27 2700K	B Black	WT White
			LM18 COB 18W		1 15°	30 3000K	S Specular	
			LM25 COB 25W		2 24°	35 3500K		
			LM32 COB 32W	3 36°	40 4000K			
			LM32 COB 32W	N No Driver A DALI	5 50°	50 5000K		

Example: DLT55-LM25E-230SWT

WAC Lighting  
www.waclighting.com (US)  
www.waclighting.com.cn (China)

Headquarters  
44 Harbor Park Drive • Port Washington, NY  
Phone (516) 515.5000 • Fax (516) 515.5050

WAC Lighting Technology (Shanghai) Co, Ltd.  
14,Lane 299, Bi Sheng Road,Shanghai 201204  
Phone (86.21) 3393.3558 • Fax (86.21) 3362.1598

# VOLTA- MODEL: DLT55

5 "square narrow edge recessed downlight



# WAC LIGHTING

Responsible Lighting®

PROJECT:

TYPE:

## Accessories

<b>LENS-DLT51-BEL</b> Striped glass lens 	<b>LENS-DLT51-HCL</b> The endless bee net grid 
---	---

Note: Up to one optical accessory can be added, the factory is not equipped with accessories, need to order separately

## LIGHT DISTRIBUTION @3000K DATA

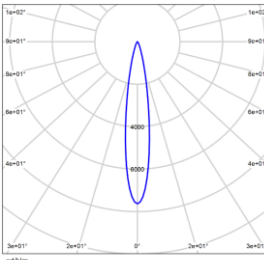
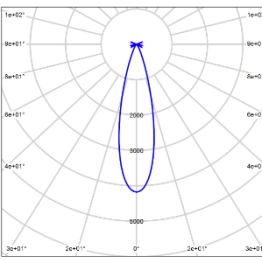
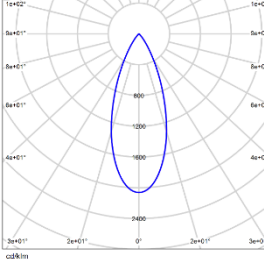
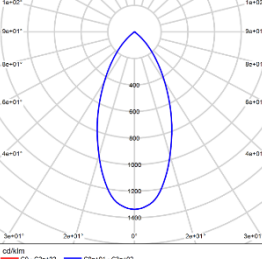
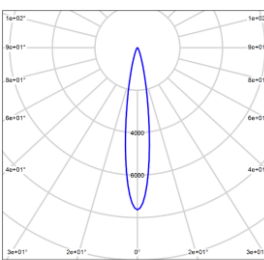
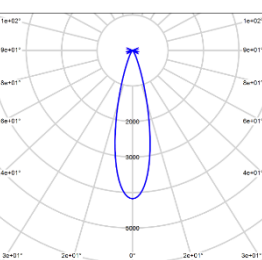
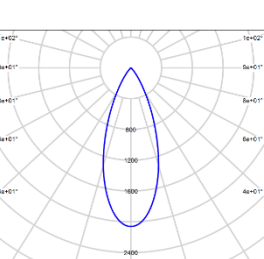
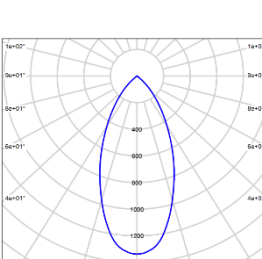
	<p><b>MODEL:</b> DLT55-LM18E-130SWT</p> <p><b>BEAM ANGLE:</b> 15°</p> <p><b>POWER:</b> 21W</p> <p><b>LUMENS:</b> 1609lm</p> <p><b>CBCP:</b> 14044cd</p> <p><b>EFFICACY:</b> 77lm/W</p>		<p><b>MODEL:</b> DLT55-LM18E-230SWT</p> <p><b>BEAM ANGLE:</b> 24°</p> <p><b>POWER:</b> 21W</p> <p><b>LUMENS:</b> 1640lm</p> <p><b>CBCP:</b> 6742cd</p> <p><b>EFFICACY:</b> 78lm/W</p>
	<p><b>MODEL:</b> DLT55-LM18E-330SWT</p> <p><b>BEAM ANGLE:</b> 36°</p> <p><b>POWER:</b> 21W</p> <p><b>LUMENS:</b> 1783lm</p> <p><b>CBCP:</b> 3738cd</p> <p><b>EFFICACY:</b> 85lm/W</p>		<p><b>MODEL:</b> DLT55-LM18E-530SWT</p> <p><b>BEAM ANGLE:</b> 50°</p> <p><b>POWER:</b> 21W</p> <p><b>LUMENS:</b> 1538lm</p> <p><b>CBCP:</b> 2311cd</p> <p><b>EFFICACY:</b> 73lm/W</p>
	<p><b>MODEL:</b> DLT55-LM25E-130SWT</p> <p><b>BEAM ANGLE:</b> 15°</p> <p><b>POWER:</b> 28W</p> <p><b>LUMENS:</b> 2111lm</p> <p><b>CBCP:</b> 18431cd</p> <p><b>EFFICACY:</b> 75lm/W</p>		<p><b>MODEL:</b> DLT55-LM25E-230SWT</p> <p><b>BEAM ANGLE:</b> 24°</p> <p><b>POWER:</b> 28W</p> <p><b>LUMENS:</b> 2152lm</p> <p><b>CBCP:</b> 8848cd</p> <p><b>EFFICACY:</b> 77lm/W</p>
	<p><b>MODEL:</b> DLT55-LM25E-330SWT</p> <p><b>BEAM ANGLE:</b> 36°</p> <p><b>POWER:</b> 28W</p> <p><b>LUMENS:</b> 2340lm</p> <p><b>CBCP:</b> 4905cd</p> <p><b>EFFICACY:</b> 84lm/W</p>		<p><b>MODEL:</b> DLT55-LM25E-530SWT</p> <p><b>BEAM ANGLE:</b> 50°</p> <p><b>POWER:</b> 28W</p> <p><b>LUMENS:</b> 2018lm</p> <p><b>CBCP:</b> 3033cd</p> <p><b>EFFICACY:</b> 72lm/W</p>

WAC Lighting  
[www.waclighting.com](http://www.waclighting.com) (US)  
[www.waclighting.com.cn](http://www.waclighting.com.cn) (China)

Headquarters  
 44 Harbor Park Drive • Port Washington, NY  
 Phone (516) 515.5000 • Fax (516) 515.5050

WAC Lighting Technology (Shanghai) Co, Ltd.  
 14,Lane 299, Bi Sheng Road,Shanghai 201204  
 Phone (86.21) 3393.3558 • Fax (86.21) 3362.1598

# VOLTA- MODEL: DLT55

5 "square narrow edge recessed downlight

# WAC LIGHTING

Responsible Lighting®

PROJECT:

TYPE:

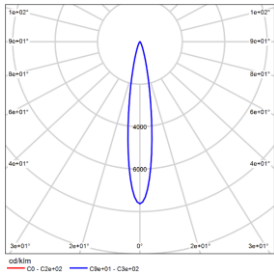

**MODEL:** DLT55-LM32E-130SWT  
**BEAM ANGLE:** 15°  
**POWER:** 35W  
**LUMENS:** 2630lm  
**CBCP:** 22965cd  
**EFFICACY:** 75lm/W

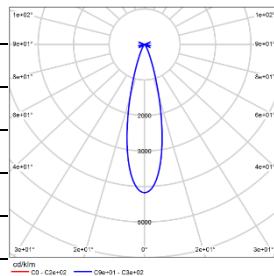

**MODEL:** DLT55-LM32E-230SWT  
**BEAM ANGLE:** 24°  
**POWER:** 35W  
**LUMENS:** 2682lm  
**CBCP:** 11024cd  
**EFFICACY:** 77lm/W

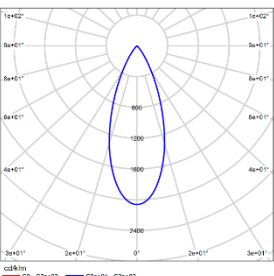

**MODEL:** DLT55-LM32E-330SWT  
**BEAM ANGLE:** 36°  
**POWER:** 35W  
**LUMENS:** 2916lm  
**CBCP:** 6112cd  
**EFFICACY:** 83lm/W

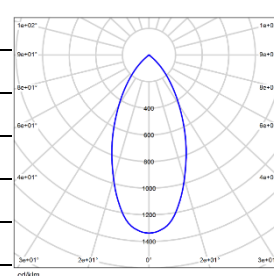

**MODEL:** DLT55-LM32E-530SWT  
**BEAM ANGLE:** 50°  
**POWER:** 35W  
**LUMENS:** 2514lm  
**CBCP:** 3779cd  
**EFFICACY:** 72lm/W

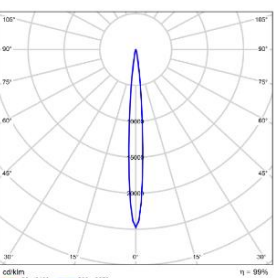

**MODEL:** DLT55-LD24E-S30SWT  
**BEAM ANGLE:** 8°  
**POWER:** 28W  
**LUMENS:** 1125lm  
**CBCP:** 27840cd  
**EFFICACY:** 40lm/W

# VOLTA- MODEL: DLT65

6 "square narrow edge recessed downlight

# WAC LIGHTING

Responsible Lighting®

PROJECT:

TYPE:

Product Image



Line Drawing

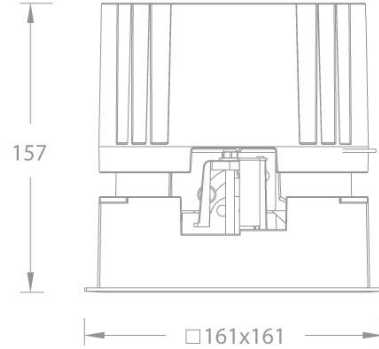

### Product Description

VOLTA series LED square narrow side embedded downlight, streamlined appearance, using accurate lens and black mirror reflector design, to ensure light while still achieve the ultimate anti-glare effect, the light source cavity is sealed design, can minimize the impact of wet environment on its performance; It can also be freely disassembled and replaced with reflectors or optical accessories, greatly improving the convenience of the site, mainly for hotels and commercial indoor places.

### Product Features

- **Body Material:** Aluminum alloy die-cast lamp body
- **Optical System:** Lens + reflector
- **Finish:** electrostatic powder spraying
- **Projection Direction:** /
- **Accessories:** see the attachment
- **Certification:** CCC
- **IP Rating:** IP20(Light source cavity IP44)
- **Insulation Level:** Class II
- **Operating Temperature:** -20°C~40°C

### Product Specification

- **Cut Out:** □150x150mm
- **Ceiling thickness:** 1mm~30mm
- **lamp shielding angle:** 30°
- **LED Type:** COB(Where 8° is HP LED)
- **Source Lm:** 2700K: 32W 2740lm; 32W 3610lm; 43W 4250lm  
3000K: 32W 2880lm; 32W 3830lm; 43W 43500lm; 32W 3000lm; 32W 4020lm; 43W 44000K: 32W 3060lm; 32W 4180lm; 43W 45000K: 32W 3100lm; 32W 4310lm; 43W 5
- **LED Lifetime:** >50000h-L70 /B10-Ta25°C(LM-80/TM-21)
- **CCT/CRI:** 2700K/3000K/3500K/4000K/5000K, CRI≥90
- **Input:** 220V AC / 50Hz
- **Dimming:** Non-dimming /0-10V/DALI(must be tested with the project site system in advance)
- **Net Weight:** Approx. 1.1Kg, without packaging

### Order Model

Model	Size	Trim	LED	Driver	Beam	CCT	Reflector	Finish
DLT Downlight T series	6"	5 Square Trim	LD32 LED 32W	E On-Off D 0-10V Dimming	S 8°	27 2700K	B Black	WT White BK Black
			LM32 COB 32W		1 15°	30 3000K	S Specular	
			LM43 COB 43W		2 24°	35 3500K		
			LM43 COB 43W	3 36°	40 4000K			
				N No Driver A DALI	5 50°	50 5000K		

示例: DLT65-LM43E-230SWT

WAC Lighting  
www.waclighting.com (US)  
www.waclighting.com.cn (China)

Headquarters  
44 Harbor Park Drive • Port Washington, NY  
Phone (516) 515.5000 • Fax (516) 515.5050

WAC Lighting Technology (Shanghai) Co, Ltd.  
14,Lane 299, Bi Sheng Road,Shanghai 201204  
Phone (86.21) 3393.3558 • Fax (86.21) 3362.1598

# VOLTA- MODEL: DLT65

6 "square narrow edge recessed downlight



# WAC LIGHTING

Responsible Lighting®

PROJECT:

TYPE:

## Accessories

<b>LENS-DLT61-BEL</b> Striped glass lens 	<b>LENS-DLT61-HCL</b> The endless bee net grid 
---	---

Note: Up to one optical accessory can be added, the factory is not equipped with accessories, need to order separately

## LIGHT DISTRIBUTION @3000K DATA

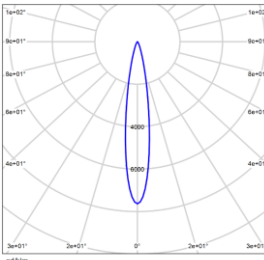
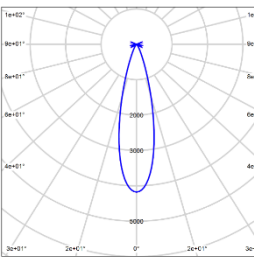
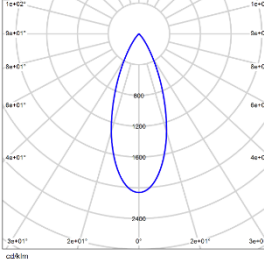
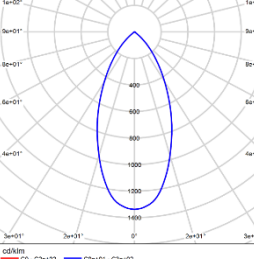
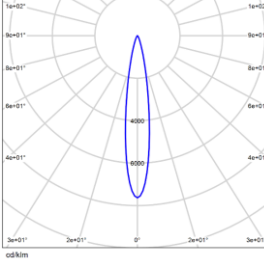
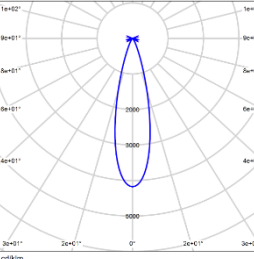
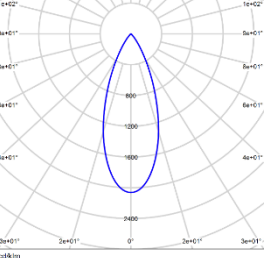
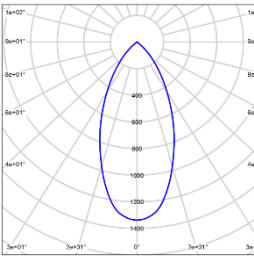
	<b>MODEL:</b> DLT65-LM32E-130SWT <b>BEAM ANGLE:</b> 15° <b>POWER:</b> 35W <b>LUMENS:</b> 2393lm <b>CBCP:</b> 23635cd <b>EFFICACY:</b> 68lm/W		<b>MODEL:</b> DLT65-LM32E-230SWT <b>BEAM ANGLE:</b> 24° <b>POWER:</b> 35W <b>LUMENS:</b> 3015lm <b>CBCP:</b> 13170cd <b>EFFICACY:</b> 86lm/W
	<b>MODEL:</b> DLT65-LM32E-330SWT <b>BEAM ANGLE:</b> 36° <b>POWER:</b> 35W <b>LUMENS:</b> 3001lm <b>CBCP:</b> 6651cd <b>EFFICACY:</b> 86lm/W		<b>MODEL:</b> DLT65-LM32E-530SWT <b>BEAM ANGLE:</b> 50° <b>POWER:</b> 35W <b>LUMENS:</b> 2830lm <b>CBCP:</b> 3762cd <b>EFFICACY:</b> 81lm/W
	<b>MODEL:</b> DLT65-LM43E-130SWT <b>BEAM ANGLE:</b> 15° <b>POWER:</b> 47W <b>LUMENS:</b> 3108lm <b>CBCP:</b> 30695cd <b>EFFICACY:</b> 66lm/W		<b>MODEL:</b> DLT65-LM43E-230SWT <b>BEAM ANGLE:</b> 24° <b>POWER:</b> 47W <b>LUMENS:</b> 3916lm <b>CBCP:</b> 17104cd <b>EFFICACY:</b> 83lm/W
	<b>MODEL:</b> DLT65-LM43E-330SWT <b>BEAM ANGLE:</b> 36° <b>POWER:</b> 47W <b>LUMENS:</b> 3897lm <b>CBCP:</b> 8638cd <b>EFFICACY:</b> 83lm/W		<b>MODEL:</b> DLT65-LM43E-530SWT <b>BEAM ANGLE:</b> 50° <b>POWER:</b> 47W <b>LUMENS:</b> 3675lm <b>CBCP:</b> 4885cd <b>EFFICACY:</b> 78lm/W

WAC Lighting  
[www.waclighting.com](http://www.waclighting.com) (US)  
[www.waclighting.com.cn](http://www.waclighting.com.cn) (China)

Headquarters  
 44 Harbor Park Drive • Port Washington, NY  
 Phone (516) 515.5000 • Fax (516) 515.5050

WAC Lighting Technology (Shanghai) Co, Ltd.  
 14, Lane 299, Bi Sheng Road, Shanghai 201204  
 Phone (86.21) 3393.3558 • Fax (86.21) 3362.1598



# VOLTA- MODEL: DLT65

6 "square narrow edge recessed downlight

# WAC LIGHTING

Responsible Lighting®

PROJECT:

TYPE:

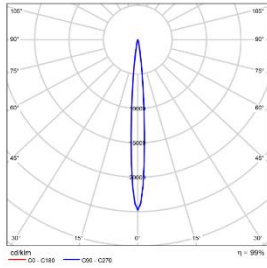

**MODEL:** DLT65-LD32E-S30SWT  
**BEAM ANGLE:** 8°  
**POWER:** 35W  
**LUMENS:** 1500lm  
**CBCP:** 37120cd  
**EFFICACY:** 43lm/W