

SWALLOW TUNABLE - MODEL: TL25HLD



W Track Luminaires

PROJECT:

TYPE:

Product Image



Line Drawing

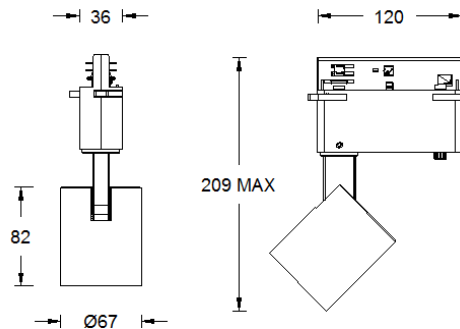

Product Description

Swallow Tunable adopts R+G+B multi-LED light source, suitable for W three-loop track, exquisite shape design, made of aluminum alloy die-cast lamp body, no visible radiator, can provide a variety of beam Angle options. This product can be used in museums, art galleries, exhibition halls, high-end commercial and residential places.

Product Features

- Body Material: Aluminum alloy die-casting lamp body, insulated pressure resistant plastic electrical box
- Optical System: Lens
- Finish: Electrostatic powder coating, black (BK), white (WT)
- Adjustable Angle: Horizontal adjustment from 0° to 355°, Vertical 0°~90° adjustment
- Accessories: Up to three optical accessories can be added; Each type of accessories can be installed at most one at the same time
- Certification: /
- IP Rating: IP20
- Insulation Level: Class III
- Operating Temperature: -20°C~40°C

Product Specifications

- LED Type: High-Power LED
- LED Power: 6W
- Source Lm: Red: 104lm; Green: 146lm; Blue: 51lm
- LED Lifetime: >50000h-L70 / B10-Ta25°C(LM-80/TM-21)
- CCT/CRI: Red: 620-630nm; Green: 520-530nm; Blue: 465-475nm
- SDCM: /
- Input: 24VDC
- Dimming: DMX512 dimming (Must conduct compatibility testing with the project site in advance)
- Net Weight: 0.6Kg without packing

Order Model

Model	LED	Dimming	Beam	CCT	Finish
TL25H Swallow Tunable	LD06 LED 6W	M DMX512 Dimming 24VDC Power Supply	S 7°	FC R+G+B	WT White BK Black
			1 14°		
			2 20°		
			3 30°		
			4 40°		
E 10*30°					
TL25H	LD06	M	2	FC	BK

Example TL25HLD06-M-2FCBK

WAC Lighting
www.waclighting.com (US)
www.waclighting.com.cn (China)

Headquarters
44 Harbor Park Drive • Port Washington, NY
Phone (516) 515.5000 • Fax (516) 515.5050

WAC Lighting(Shanghai)
14, Lane 299, Bi Sheng Road, Shanghai 201204
Phone (86.21) 3393.3558 • Fax (86.21) 3362.1598

SWALLOW TUNABLE - MODEL: TL25HLD









W Track Luminaires



PROJECT:

TYPE:

Accessory

First class fittings	LENS-16-BEL-C Striped glass lens 	LENS-16-BSL-SW Soft glass lenses 	LENS-16-FR Frosted glass lenses 	LENS-16-HCL The endless bee net grille 
Second class fittings	LENS-16-SNOOT Anti-glare tube 	LENS-16-CRL Anti-glare cross grille 	LENS-16-HCM Anti-glare bee-net grille 	
Three types of accessories	TL-21-BD-SW Four leaf shade 			

Note: Up to three optical accessories can be added, and each type of accessories can only be added one at a time

LIGHT DISTRIBUTION@3000K LUMINAIRE DATA

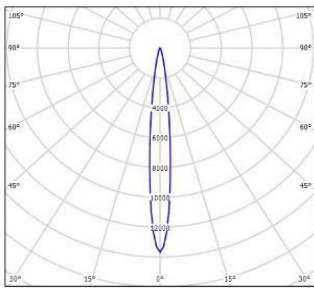

MODEL: TL25HLD06-M-SFC
BEAM ANGLE: 7°
POWER: 9W
LUMENS: 286lm
CBCP: 4362cd
EFFICACY: 30lm/W

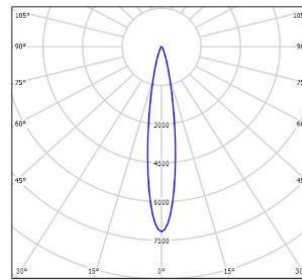

MODEL: TL25HLD06-M-1FC
BEAM ANGLE: 14°
POWER: 9W
LUMENS: 286lm
CBCP: 2322cd
EFFICACY: 30lm/W

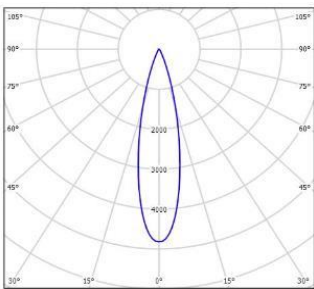

MODEL: TL25HLD06-M-2FC
BEAM ANGLE: 20°
POWER: 9W
LUMENS: 297lm
CBCP: 1592cd
EFFICACY: 31lm/W

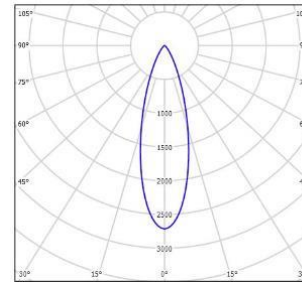

MODEL: TL25HLD06-M-3FC
BEAM ANGLE: 30°
POWER: 9W
LUMENS: 290lm
CBCP: 820cd
EFFICACY: 30lm/W

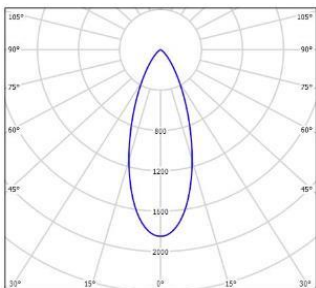

MODEL: TL25HLD06-M-4FC
BEAM ANGLE: 40°
POWER: 9W
LUMENS: 286lm
CBCP: 531cd
EFFICACY: 30lm/W

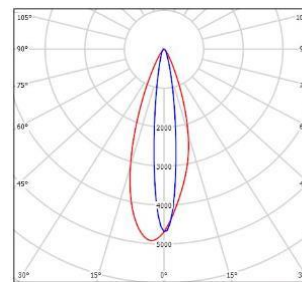

MODEL: TL25HLD06-M-EFC
BEAM ANGLE: 10*30°
POWER: 9W
LUMENS: 280lm
CBCP: 1381cd
EFFICACY: 29lm/W

Note: The above test results are the maximum value when all R+G+B is lit, 10*30°(E) represents the transverse light spot.

SWALLOW TUNABLE - MODEL: TL26HLD



W Track Luminaires

PROJECT:

TYPE:

Product Image

Line Drawing

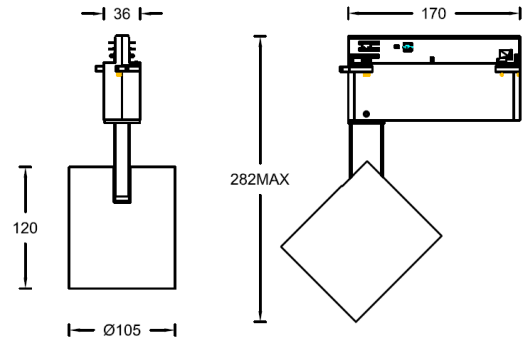

Product Description

Swallow Tunable adopts R+G+B multi-LED light source, suitable for W three-loop track, exquisite shape design, made of aluminum alloy die-cast lamp body, no visible radiator, can provide a variety of beam Angle options. This product can be used in museums, art galleries, exhibition halls, high-end commercial and residential places.

Product Features

- Body Material: Aluminum alloy die-casting lamp body, insulated pressure resistant plastic electrical box
- Optical System: Lens
- Finish: Electrostatic powder coating, black (BK) ,white (WT)
- Adjustable Angle: Horizontal adjustment from 0° to 355°, Vertical 0°~90° adjustment
- Accessories: Up to three optical accessories can be added; Each type of accessories can be installed at most one at the same time
- Certification: /
- IP Rating: IP20
- Insulation Level: Class III
- Operating Temperature: -20°C~40°C

Product Specifications

- LED Type: High-Power LED
- LED Power: 12W
- Source Lm: Red: 208lm; Green: 292lm; Blue: 102lm
- LED Lifetime: >50000h-L70 / B10-Ta25°C(LM-80/TM-21)
- CCT/CRI: Red: 620-630nm; Green: 520-530nm; Blue: 465-475nm
- SDCM: /
- Input: 24VDC
- Dimming: DMX512 dimming (Must conduct compatibility testing with the project site in advance)
- Net Weight: 1.3Kg without packing

Order Model

Model	LED	Dimming	Beam	CCT	Finish
TL26H Swallow Tunable	LD12 LED 12W	M DMX512 Dimming 24VDC Power Supply	S 7°	FC R+G+B	WT White BK Black
			1 14°		
			2 20°		
			3 30°		
			4 40°		
			E 10*30°		
TL26H	LD12	M	2	FC	BK

Example TL26HLD12-M-2FCBK

WAC Lighting
www.waclighting.com (US)
www.waclighting.com.cn (China)

Headquarters
44 Harbor Park Drive • Port Washington, NY
Phone (516) 515.5000 • Fax (516) 515.5050

WAC Lighting(Shanghai)
14, Lane 299, Bi Sheng Road, Shanghai 201204
Phone (86.21) 3393.3558 • Fax (86.21) 3362.1598

SWALLOW TUNABLE - MODEL: TL26HLD









W Track Luminaires



PROJECT:

TYPE:

Accessory

First class fittings	LENS-25-BEL-SW Striped glass lens 	LENS-25-BSL Soft glass lenses 	LENS-25-FR - SW Frosted glass lenses 	LENS-25-LCM-SW The endless bee net grille 
Second class fittings	LENS-25-SNOOT-SW Anti-glare tube 	LENS-25P-CRL-BK Anti-glare cross grille 	LENS-25-HCL Anti-glare bee-net grille 	
Three types of accessories	TL-22-BD-SW Four leaf shade 			

Note: Up to three optical accessories can be added, and each type of accessories can only be added one at a time

LIGHT DISTRIBUTION@3000K LUMINAIRE DATA

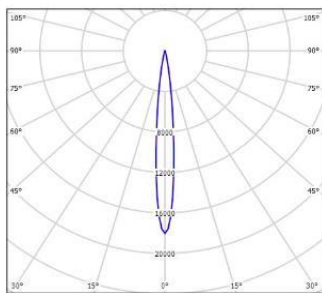

MODEL: TL26HLD12-M-SFC
BEAM ANGLE: 7°
POWER: 15W
LUMENS: 584lm
CBCP: 10703cd
EFFICACY: 36lm/W

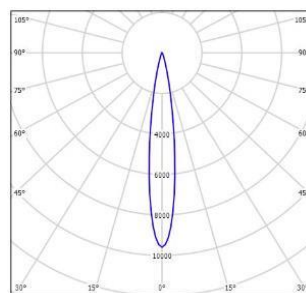

MODEL: TL26HLD12-M-1FC
BEAM ANGLE: 14°
POWER: 15W
LUMENS: 609lm
CBCP: 5844cd
EFFICACY: 37lm/W

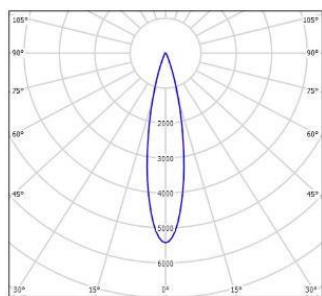

MODEL: TL26HLD12-M-2FC
BEAM ANGLE: 20°
POWER: 15W
LUMENS: 581lm
CBCP: 3173cd
EFFICACY: 36lm/W

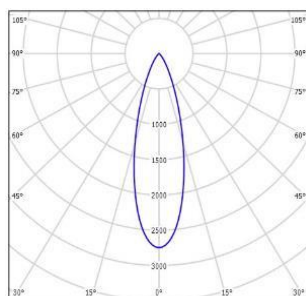

MODEL: TL26HLD12-M-3FC
BEAM ANGLE: 30°
POWER: 15W
LUMENS: 589lm
CBCP: 1625cd
EFFICACY: 36lm/W

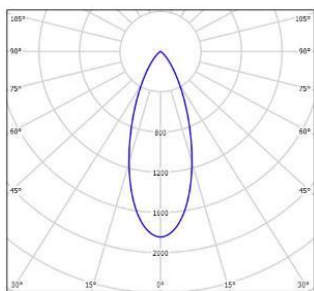

MODEL: TL26HLD12-M-4FC
BEAM ANGLE: 40°
POWER: 15W
LUMENS: 569lm
CBCP: 1051cd
EFFICACY: 35lm/W

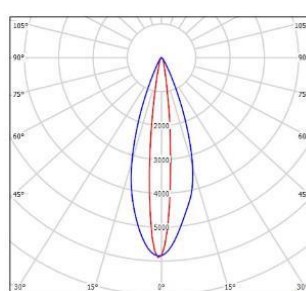

MODEL: TL26HLD12-M-EFC
BEAM ANGLE: 10*30°
POWER: 15W
LUMENS: 588lm
CBCP: 3481cd
EFFICACY: 36lm/W

Note: The above test results are the maximum value when all R+G+B is lit, 10*30°(E) represents the transverse light spot.

SWALLOW TUNABLE - MODEL: TL27HLD

W Track Luminaires

PROJECT:

TYPE:

Product Image



Line Drawing

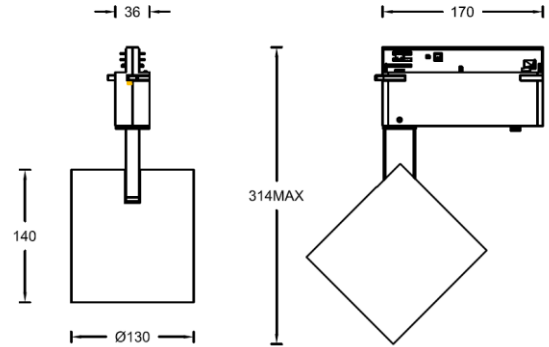

Product Description

Swallow Tunable adopts R+G+B multi-LED light source, suitable for W three-loop track, exquisite shape design, made of aluminum alloy die-cast lamp body, no visible radiator, can provide a variety of beam Angle options. This product can be used in museums, art galleries, exhibition halls, high-end commercial and residential places.

Product Features

- Body Material: Aluminum alloy die-casting lamp body, insulated pressure resistant plastic electrical box
- Optical System: Lens
- Finish: Electrostatic powder coating, black (BK), white (WT)
- Adjustable Angle: Horizontal adjustment from 0° to 355°, Vertical 0°~90° adjustment
- Accessories: Up to three optical accessories can be added; Each type of accessories can be installed at most one at the same time
- Certification: /
- IP Rating: IP20
- Insulation Level: Class III
- Operating Temperature: -20°C~40°C

Product Specifications

- LED Type: High-Power LED
- LED Power: 18W / 24W / 30W Optional
- Source Lm: 18W: Red:312lm; Green:438lm; Blue:153lm
24W: Red:416lm; Green:584lm; Blue:204lm
30W: Red:520lm; Green:730lm; Blue:255lm
- LED Lifetime: >50000h-L70 / B10-Ta25°C(LM-80/TM-21)
- CCT/CRI: Red: 620-630nm; Green: 520-530nm; Blue: 465-475nm
- SDCM: /
- Input: 24VDC
- Dimming: DMX512 dimming (Must conduct compatibility testing with the project site in advance)
- Net Weight: 2.0Kg without packing

Order Model

Model	LED	Dimming	Beam	CCT	Finish
TL27H Swallow Tunable	LD18 LED 18W LD24 LED 24W LD30 LED 30W	M DMX512 Dimming 24VDC Power Supply	S 7°	FC R+G+B	WT White BK Black
			1 14°		
			2 20°		
			3 30°		
			4 40°		
E 10*30°					
TL27H	LD30	M	2	FC	BK

Example TL27HLD30-M-2FCBK

SWALLOW TUNABLE - MODEL: TL27HLD









W Track Luminaires



PROJECT:

TYPE:

Accessory

First class fittings	LENS-111-BEL-SW Striped glass lens 	LENS-111-BSL Soft glass lenses 	LENS-111-FR Frosted glass lenses 	LENS-111-LCM-SW The endless bee net grille 
Second class fittings	LENS-111-SNOOT Anti-glare tube 	LENS-111-CRL-C Anti-glare cross grille 	LENS-111-HCL Anti-glare bee-net grille 	
Three types of accessories	TL-23-BD-SW Four leaf shade 			

Note: Up to three optical accessories can be added, and each type of accessories can only be added one at a time

LIGHT DISTRIBUTION@3000K LUMINAIRE DATA

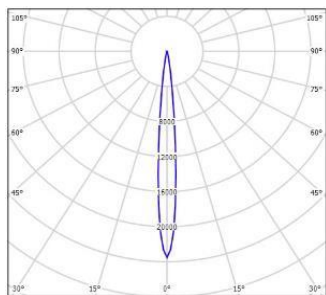

MODEL: TL27HLD18-M-SFC
BEAM ANGLE: 7°
POWER: 22W
LUMENS: 781lm
CBCP: 20393cd
EFFICACY: 35lm/W

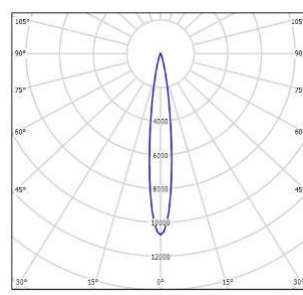

MODEL: TL27HLD18-M-1FC
BEAM ANGLE: 14°
POWER: 22W
LUMENS: 786lm
CBCP: 8556cd
EFFICACY: 35lm/W

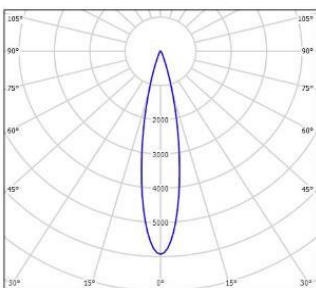

MODEL: TL27HLD18-M-2FC
BEAM ANGLE: 20°
POWER: 22W
LUMENS: 778lm
CBCP: 4621cd
EFFICACY: 35lm/W

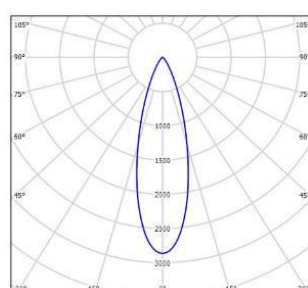

MODEL: TL27HLD18-M-3FC
BEAM ANGLE: 30°
POWER: 22W
LUMENS: 767lm
CBCP: 2198cd
EFFICACY: 34lm/W

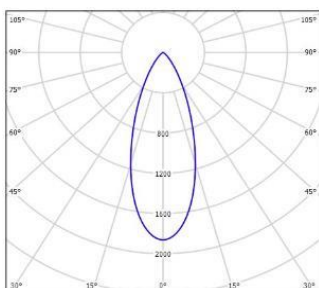

MODEL: TL27HLD18-M-4FC
BEAM ANGLE: 40°
POWER: 22W
LUMENS: 740lm
CBCP: 1354cd
EFFICACY: 33lm/W

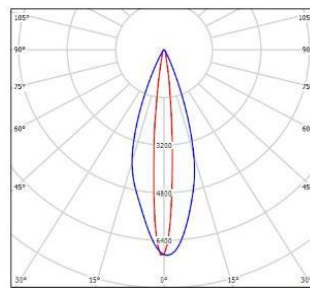

MODEL: TL27HLD18-M-EFC
BEAM ANGLE: 10*30°
POWER: 22W
LUMENS: 775lm
CBCP: 5103cd
EFFICACY: 35lm/W

SWALLOW TUNABLE - MODEL: TL27HLD

W Track Luminaires

WAC

PROJECT:

TYPE:

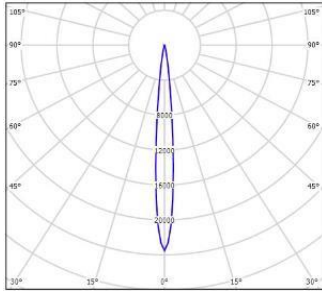

MODEL: TL27HLD24-M-SFC

BEAM ANGLE: 7°

POWER: 28W

LUMENS: 1066lm

CBCP: 26623cd

EFFICACY: 36lm/W

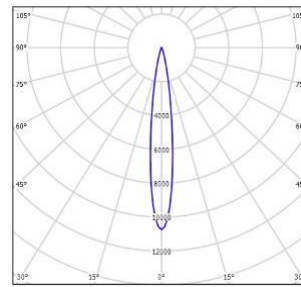

MODEL: TL27HLD24-M-1FC

BEAM ANGLE: 14°

POWER: 28W

LUMENS: 1073lm

CBCP: 11668cd

EFFICACY: 37lm/W

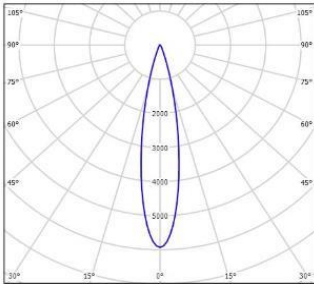

MODEL: TL27HLD24-M-2FC

BEAM ANGLE: 20°

POWER: 28W

LUMENS: 1067lm

CBCP: 6380cd

EFFICACY: 37lm/W

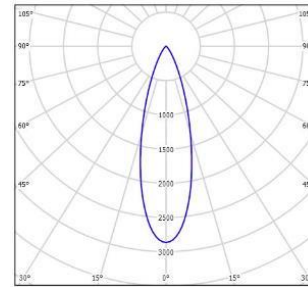

MODEL: TL27HLD24-M-3FC

BEAM ANGLE: 30°

POWER: 28W

LUMENS: 1070lm

CBCP: 3076cd

EFFICACY: 36lm/W

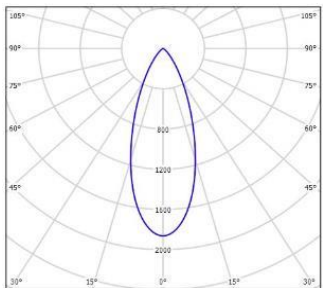

MODEL: TL27HLD24-M-4FC

BEAM ANGLE: 40°

POWER: 28W

LUMENS: 1026lm

CBCP: 1919cd

EFFICACY: 36lm/W

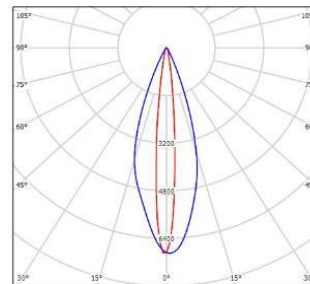

MODEL: TL27HLD24-M-EFC

BEAM ANGLE: 10*30°

POWER: 28W

LUMENS: 1071lm

CBCP: 7438cd

EFFICACY: 37lm/W

SWALLOW TUNABLE - MODEL: TL27HLD

W Track Luminaires



PROJECT:

TYPE:

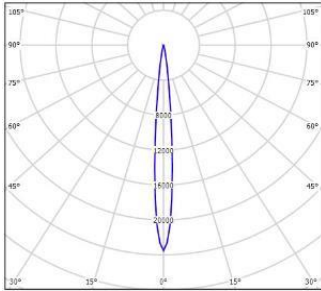

MODEL: TL27HLD30-M-SFC
BEAM ANGLE: 7°
POWER: 34W
LUMENS: 1290lm
CBCP: 24794cd
EFFICACY: 37lm/W

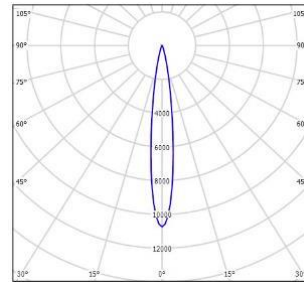

MODEL: TL27HLD30-M-1FC
BEAM ANGLE: 14°
POWER: 34W
LUMENS: 1347lm
CBCP: 12906cd
EFFICACY: 37lm/W

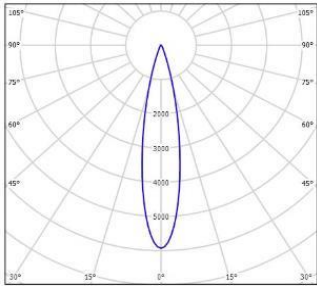

MODEL: TL27HLD30-M-2FC
BEAM ANGLE: 20°
POWER: 34W
LUMENS: 1242lm
CBCP: 6852cd
EFFICACY: 36lm/W

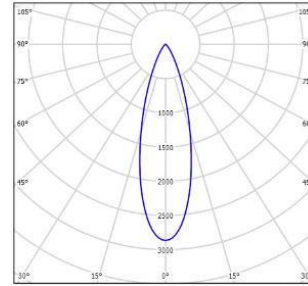

MODEL: TL27HLD30-M-3FC
BEAM ANGLE: 30°
POWER: 34W
LUMENS: 1279lm
CBCP: 3591cd
EFFICACY: 37lm/W

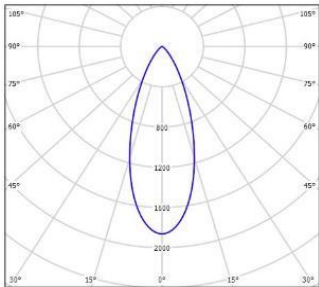

MODEL: TL27HLD30-M-4FC
BEAM ANGLE: 40°
POWER: 34W
LUMENS: 1268lm
CBCP: 2331cd
EFFICACY: 37lm/W

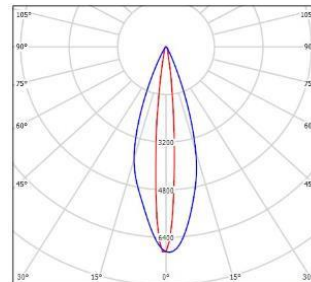

MODEL: TL27HLD30-M-EFC
BEAM ANGLE: 10*30°
POWER: 34W
LUMENS: 1206lm
CBCP: 7204cd
EFFICACY: 35lm/W

Note: The above test results are the maximum value when all R+G+B is lit, 10*30°(E) represents the transverse light spot.