

# ACCENT D1 - MODEL: ELD1

Linear Luminaires

# WAC

PROJECT:

TYPE:

## Product Image



## Line Drawing

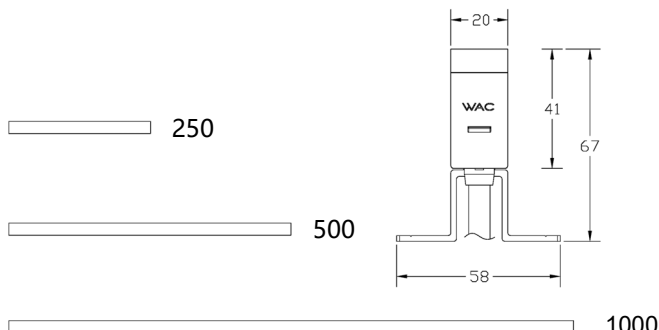

## Product Description

The Accent series lighting fixtures use high light efficiency and long lifespan light sources, with an evenly spaced layout design to ensure uniform light output and no shadows. Accent linear lighting fixtures meet the requirements of LEED outdoor lighting power consumption design, and their clean and lightweight appearance ensures easy assembly to the exterior walls. Accent lighting fixtures are equipped with flexible cables, allowing for free selection of side or bottom outlets to meet project requirements. The lighting fixtures support DMX512 dimming control with automatic addressing function; The protection level of IP66 for the entire lamp can be widely used in various building lighting, etc.

## Product Features

- Body Material: Aluminum + PC94V0
- Optical System: PC Diffuser
- Finish: Static electricity powder coating
- Adjustable Angle: /
- Accessories: Aluminum alloy card installation
- Certification: /
- IP Rating: IP66
- Insulation Level: Class III
- Operating Temperature: -20°C~50°C

## Product Specifications

- LED Type: SMD
- Light Power: 12W (Max) / 1000mm
- Source LM: 2700K 1344lm / 3000K 1344lm / 4000K 1440lm
- LED Lifetime: >50000h-L70 /B10-Ta25°C(LM-80/TM-21)
- CCT/CRI: 2700K / 3000K / 4000K / Ra80 RGB
- SDCM: 3 SDCM
- Input: 24V DC
- Dimming: On-off / DMX512
- Net Weight: 0.6Kg without packing

## Order Model

Model	Length (mm)	Power (W)	LEDs (Quantity)	Max Lumens (lm)	Control Systems	Beam	Phase Controller	CCT	Finish
ELD103-03	250	3(Max)	12	153	ET ON-OFF 24V DC Power Supply	P Three sided luminescence	0 W/O hase	27 2700K	BK Black
ELD105-06	500	6(Max)	24	305				30 3000K	
ELD110-12	1000	12(Max)	48	610				40 4000K	

Example: ELD110-12ET-P027BK

# ACCENT D1 - MODEL: ELD1

Linear Luminaires









PROJECT:

TYPE:

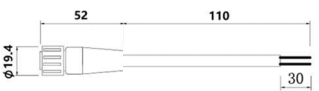
Model	Length (mm)	Power (W)	LEDs (Quantity)	Max Lumens (lm)	Control Systems	Beam	Phase Controller	CCT	Finish
ELD103-03	250	3(Max)	12	153	MT DMX512 Dimming 24V DC Power Supply	P Three sided luminescence	1 1 Phase 4 4 Phase 8 8 Phase	27 2700K 30 3000K 40 4000K FC RGB	BK Black
ELD105-06	500	6(Max)	24	305					
ELD110-12	1000	12(Max)	48	610					

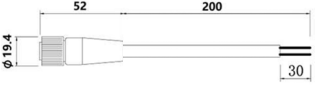
Example: ELC710-12MT-2130BK

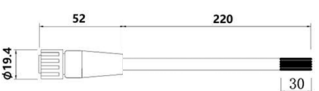
## Accessory

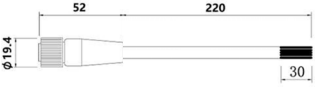
Item	Description	Pic	Description Dimensions	Quantity Suggested
ELD1-PC-CT002F	ET Female connector			1 pc per 8m
ELD1-PC-CT002M	ET Male connector			1 pc per 8m
ELD1-CC-CT002F	MT Female connector			1 pc per 8m
ELD1-CC-CT002M	MT Male connector			1 pc per 8m

## LIGHT DISTRIBUTION@3000K LUMINAIRE DATA

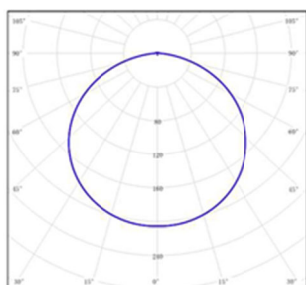

MODEL:	ELD110-12ET-P030BK
BEAM ANGLE:	135°
POWER:	12.8W
LUMENS:	308 lm
CBCP:	/
EFFICACY:	24 lm/W